

90cm Undermount Rangehood



FEATURES

Perimeter extraction, Aluminium filters,
750m³/hr extraction, Electronic controls,
3 speeds + Boost, 2 × LED lights

Congratulations on your new InAlto 90cm Undermount Rangehood!

INSTALLATION

Please refer to the dimensions of your rangehood shown in the diagram below.

When positioning the rangehood for installation and use, we advise that the rangehood is mounted at a height of between 600–800mm above the cooking surface for safety and performance of your rangehood.

Gas cooktops must have a minimum of height of 650mm from the burner to the underside of the rangehood.

Electric cooktops must have a minimum height of 600mm from the cooktop surface to the underside of the rangehood.

For a complete guide, refer to the user manual pages 8, 10–12.

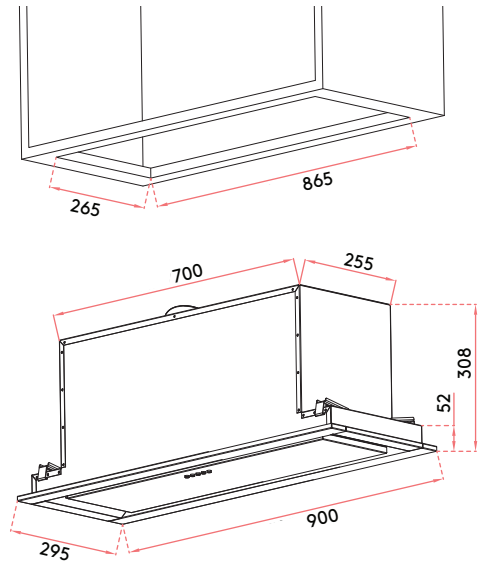

THE CONTROLS

Your Undermount Rangehood Controls

- 1 Low Fan Speed
- 2 Medium Fan Speed
- 3 High Fan Speed
- 4 Boost Fan Speed
- 5 Light

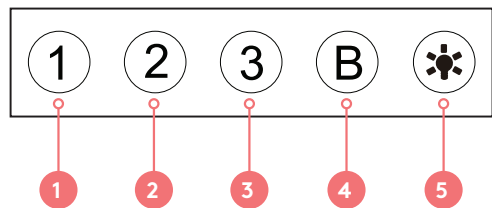

For a complete guide on operating your rangehood refer to user manual on page 13.

DETAILS

Product Size (W, D, H):
900mm x 295mm x 308mm

SUPPORT

Telephone: 1300 11 4357
Email: support@residentiagroup.com.au