

USER MANUAL

INALTO?

INALTO.HOUSE

Portable Air-conditioner

MODEL CODE/S

IAP2740W

IAP3000W

IAP3800W



A HIGHER LEVEL OF LIVING

V.3 | 0920

Welcome!

Residentia Group Pty Ltd
ACN. 600 546 656
165 Barkly Avenue
Burnley, Victoria
Australia 3121

—
Applico Ltd
635 Great South Road
Penrose, Auckland 1061
New Zealand

Congratulations on purchasing your new appliance!

The InAlto brand is proudly distributed within Australia by Residentia Group Pty Ltd and within New Zealand by Applico Ltd.

Please refer to the warranty card at the rear of this manual for information regarding your product's parts and labour warranty, or visit online at:

- www.residentia.group
- www.applico.co.nz
- www.inalto.house

Both Residentia Group & Applico are customer obsessed and our Support Teams are there to ensure you get the most out of your appliance. Should you want to learn more about recommended usage, the various features of your appliance, and importantly taking care of the unit when cleaning, our Support Teams are here to help.

Telephone Contacts:

- AU: 1300 11 4357
- NZ: 0800 763 448

It is important that you read through the following use and care manual thoroughly to familiarise yourself with the installation and operation requirements of your appliance to ensure optimum performance.

Again, thank you for choosing an InAlto appliance and we look forward to being of service to you.

Contents

- 2 Welcome**
- 4 Safety Instructions**
- 10 Your Portable Air-conditioner**
- 12 Installation**
- 14 Getting Started**
- 16 Operation Instructions**
- 18 Troubleshooting**
- 19 Technical Data**
- 20 Other Useful Information**
- 22 Your Receipt**
- 23 Purchase Details**
- 24 Warranty Information**

Safety Instructions

READ CAREFULLY AND KEEP FOR FUTURE REFERENCE

Read this manual thoroughly before first use, even if you are familiar with this type of product. The safety precautions enclosed herein reduce the risk of fire, electric shock and injury when correctly adhered to. Make sure you understand all instructions and warnings. Keep the manual in a safe place for future reference, along with the completed warranty card and purchase receipt. If you sell or transfer ownership of this product, pass on these instructions to the new owner.

Always follow basic safety precautions and accident prevention measures when using an electrical appliance, including the following:

ELECTRICAL SAFETY AND CORD HANDLING

- Voltage: Before turning on the air conditioner, ensure the electrical voltage and circuit frequency correspond to those indicated on the appliance.
- Socket: Ensure your electrical outlet is properly installed and earthed and complies with your local electrical safety requirements.
- Moisture: To reduce the risk of electrocution, never operate the appliance with wet hands; never submerge it in water or spill liquids into it. Do not use it in a bathroom or laundry, or where it can be splashed with water.
- Power supply cord: Do not kink or damage the cord. Do not pull the cord or place it near a heat source. Always unwind the cord completely to avoid overheating. Run the cord in such a way so that no one will trip over it.
- Extension cord/adaptor: Do not use this appliance with an extension cord or power adaptor.
- Damaged cord: If the supply cord is damaged, do not use the appliance. A damaged power supply cord must be replaced by the manufacturer or its service agent or a similarly qualified person in order to avoid a hazard. Contact our after sales support centre.
- WARNING: Do not use when damaged! In case of damage, switch off the appliance, unplug it and contact our after sales support centre. Do not pick up or operate a damaged appliance, or after it malfunctions or has been dropped or damaged in any manner.
- Power button: Always use the on/off button on the control panel to turn the product on or off. Never simply switch the product on or off by plugging it into or unplugging it from the wall socket.

- Disconnect: Turn off the unit first and then unplug it when it is not in use and before maintenance or cleaning, but do not unplug it when it is in operation, as this could create a spark and cause a fire. Grip by the plug, do not pull by the cord when disconnecting.
- RCD: The installation of a residual current device (safety switch) is recommended to provide additional safety protection when using electrical appliances. It is advisable that a safety switch with a rated residual operating current not exceeding 30mA be installed in the electrical circuit supplying the appliance. See your electrician for professional advice.
- Never try to open the housing, modify or alter the product in any way.

USAGE CONDITIONS AND RESTRICTIONS

- Intended use: This appliance is intended for air conditioning domestic environments. It is not suitable for commercial, industrial or trade use. Do not use it for any other purpose (such as cooling food, etc.) and only use it as described in this manual.
- Common sense: These instructions are not intended to cover every possible condition and situation. As with any electrical appliance, common sense and caution are therefore always recommended when installing, operating and maintaining the unit.
- No outdoor use: Do not use the unit outdoors. It is for indoor use only.
- Usage restriction: This appliance is not intended for use by persons (including children) with reduced physical, sensory or mental capabilities, or lack of experience and knowledge, unless they have been given supervision or instruction concerning use of the appliance in a safe way and understand the hazards involved.
- No external timer: This appliance is not intended to be used with an external timer or a separate remote control system.
- WARNING: Do not cover! Do not cover the air conditioner or obstruct any air inlet or outlet grilles. Obstructing these openings causes a fire hazard, reduces the operating efficiency and may lead to malfunction or damage.
- Air outlets: Do not insert any objects, or your fingers, into the air outlet, and make sure to warn children of the dangers.
- Children: Supervise children to ensure they do not play with the appliance. Close supervision is necessary when any appliance is used by or near children. Cleaning and user maintenance shall not be made by children without supervision.

- Unattended: Do not leave the appliance unattended when in use.
- Attachments: The use of attachments not recommended or sold by the manufacturer may cause fire, electric shock or injury.
- Startup settings: Set the unit to maximum cooling and high speed ventilation for the initial startup, then adjust the unit down to a more comfortable setting as required.
- Airflow: Do not direct the airflow onto plants or animals, as long and direct exposure to cold air from the air conditioner could adversely affect them.
- Cold air exposure: Never remain directly exposed to the flow of cold air for a long time, as direct and prolonged exposure to cold air from the air conditioner could be dangerous for your health. Take particular care in rooms where there are children, old, or sick people.
- Moving the appliance: When moving the air conditioner, always turn off and disconnect the power supply, and move it slowly.
- Never place any objects containing liquid, such as flower vases or drinks, on top of the product.
- Never handle the product with wet hands or while barefoot.
- Switch off and unplug the product when it is not in use.
- WARNING! If the product should tip over, immediately turn it off and unplug it.

CLEANING AND MAINTENANCE

- Disconnect: Make sure the appliance is disconnected from the power supply when it will not be used for a long time and before carrying out any cleaning or maintenance.
- Air filter: Keep the air filter clean. Do not use the unit without the air filters fitted. Using it without air filters could cause an excessive accumulation of dust or waste on the inner parts of the device with possible subsequent failures.
- Service and repair: The air conditioner has no user-serviceable parts contained inside. Do not attempt to disassemble, modify or conduct repairs on this unit. It has been built in accordance with relevant safety and performance standards. An electrical specialist must carry out all repairs. Contact our after sales support line for advice on service.
- Cooling efficiency: To help cooling efficiency, keep blinds and curtains closed during the sunniest part of the day. Close off any fireplace damper, floor and/or wall register so cool air does not escape through the chimney or duct work.

INSTALLATION

- Proper installation: Install the appliance according to the instructions in this manual and national wiring regulations. Improper installation may result in the risk of fire, electric shock and/or injury. We assume no responsibility for any eventual damages caused by improper installation or faulty use.
- Upright position: Place the unit on a flat surface to reduce the risk of it tipping over. Do not tilt the unit, always keep it upright. If the unit has not been kept upright (such as during storage), wait for at least 24 hours before operation.
- Obstructions: Do not locate the air conditioner where furniture or other objects can obstruct the airflow.
- Do not cover: Do not cover the air conditioner or obstruct any air inlet or outlet grilles. Obstructing these openings causes a fire hazard, reduces the operating efficiency and may lead to malfunction or damage.
- Chemicals: Do not install the air conditioner in environments where the air could contain gas, oil or sulphur. Do not let chemical substances come into contact with the unit. Do not use the unit in the presence of flammable substances or vapour such as alcohol, insecticides, petrol etc.
- Heat: Do not install the air conditioner near sources of heat, or exposed to direct sunlight.
- Clearances: Always keep a clearance of at least 30cm from walls, furniture and curtains.

This symbol shows that this appliance uses a flammable refrigerant (R290). If the refrigerant is leaked and exposed to an external ignition



source, there is a risk of fire.

NOTE ABOUT FLUORINATED GAS (NOT APPLICABLE TO UNITS USING R290 REFRIGERANT)

- Fluorinated greenhouse gases are contained in hermetically sealed equipment. For specific information on the type, the amount and the CO2 equivalent in tonnes of the fluorinated greenhouse gas (on some models), please refer to the relevant label on the unit itself.
- Installation, service, maintenance and repair of this unit must be performed by a certified technician.
- Product uninstallation and recycling must be performed by a certified technician.

Safety Instructions (Continued)

WARNING FOR USING R32/R290 REFRIGERANT

- Do not use means to accelerate the defrosting process or to clean, other than those recommended by the manufacturer.
- The appliance shall be stored in a room without continuously operating ignition sources (for example: open flames, an operating gas appliance or an operating electric heater).
- Do not pierce or burn.
- Be aware that the refrigerants may not contain an odour.
- Appliance should be installed, operated and stored in a room with a floor area according to the amount of refrigerant to be charged. For specific information on the type of gas and the amount, please refer to the relevant label on the unit itself. When there are differences between the label and the manual on the Min. room area description, the description on label shall prevail.

For R290:

Amount of refrigerant (kg)	Min. room area (m ²)
> 0.0836 and ≤ 0.1045	5
> 0.1045 and ≤ 0.1254	6
> 0.1254 and ≤ 0.1463	7
> 0.1463 and ≤ 0.1672	8
> 0.1672 and ≤ 0.1881	9
> 0.1881 and ≤ 0.2090	10
> 0.2090 and ≤ 0.2299	11
> 0.2299 and ≤ 0.2508	12
> 0.2508 and ≤ 0.2717	13
> 0.2717 and ≤ 0.2926	14
> 0.2926 and ≤ 0.3135	15

- Compliance with national gas regulations shall be observed.
- Keep ventilation openings clear of obstruction.
- The appliance shall be stored so as to prevent mechanical damage from occurring.
- A warning that the appliance shall be stored in a well-ventilated area where the room size corresponds to the room area as specified for operation.
- Any person who is involved with working on or breaking into a refrigerant circuit should hold a current valid certificate from an industry-accredited assessment authority, which authorises their competence to handle refrigerants safely in accordance with an industry recognised assessment specification.

- Servicing shall only be performed as recommended by the equipment manufacturer. Maintenance and repair requiring the assistance of other skilled personnel shall be carried out under the supervision of the person competent in the use of flammable refrigerants.
- The appliance shall be stored in a room without continuously operating open flames (for example an operating gas appliance) and ignition sources (for example an operating electric heater).



**Caution: Risk of fire/
flammable materials**

Explanation of symbols displayed on the unit
(For the unit adopts R32/R290 Refrigerant only):

	WARNING	This symbol shows that this appliance used a flammable refrigerant. If the refrigerant is leaked and exposed to an external ignition source, there is a risk of fire.
	CAUTION	This symbol shows that the operation manual should be read carefully.
	CAUTION	This symbol shows that a service personnel should be handling this equipment with reference to the installation manual.
	CAUTION	This symbol shows that information is available such as the operating manual or installation manual

Transport of equipment containing flammable refrigerants

See transport regulations

Marking of equipment using signs

See local regulations

Disposal of equipment using flammable refrigerants

See national regulations.

Storage of equipment/appliances

The storage of equipment should be in accordance with the manufacturer's instructions.

Storage of packed (unsold) equipment

Storage package protection should be constructed such that mechanical damage to the equipment inside the package will not cause a leak of the refrigerant charge. The maximum number of pieces of equipment permitted to be stored together will be determined by local regulations.

Information on servicing

1. Checks to the area

Prior to beginning work on systems containing flammable refrigerants, safety checks are necessary to ensure that the risk of ignition is minimised. For repair to the refrigerating system, the following precautions shall be complied with prior to conducting work on the system.

2. Work procedure

Work shall be undertaken under a controlled procedure so as to minimise the risk of a flammable gas or vapour being present while the work is being performed.

3. General work area

All maintenance staff and others working in the local area shall be instructed on the nature of work being carried out. Work in confined spaces shall be avoided. The area around the workspace shall be sectioned off. Ensure that the conditions within the area have been made safe by control of flammable material.

4. Checking for presence of refrigerant

The area shall be checked with an appropriate refrigerant detector prior to and during work, to ensure the technician is aware of potentially flammable atmospheres. Ensure that the leak detection equipment being used is suitable for use with flammable refrigerants, i.e. non-sparking, adequately sealed or intrinsically safe.

5. Presence of fire extinguisher

If any hot work is to be conducted on the refrigeration equipment or any associated parts, appropriate fire extinguishing equipment shall be

available to hand. Have a dry powder or CO₂ fire extinguisher adjacent to the charging area.

6. No ignition sources

No person carrying out work in relation to a refrigeration system which involves exposing any pipe work that contains or has contained flammable refrigerant shall use any sources of ignition in such a manner that it may lead to the risk of fire or explosion. All possible ignition sources, including cigarette smoking, should be kept sufficiently far away from the site of installation, repairing, removing and disposal, during which flammable refrigerant can possibly be released to the surrounding space. Prior to work taking place, the area around the equipment is to be surveyed to make sure that there are no flammable hazards or ignition risks. No Smoking signs shall be displayed.

7. Ventilated area

Ensure that the area is in the open or that it is adequately ventilated before breaking into the system or conducting any hot work. A degree of ventilation shall continue during the period that the work is carried out. The ventilation should safely disperse any released refrigerant and preferably expel it externally into the atmosphere.

8. Checks to the refrigeration equipment

Where electrical components are being changed, they shall be fit for the purpose and to the correct specification. At all times the manufacturer's maintenance and service guidelines shall be followed. If in doubt consult the manufacturer's technical department for assistance. The following checks shall be applied to installations using flammable refrigerants:

The charge size is in accordance with the room size within which the refrigerant containing parts are installed;

The ventilation machinery and outlets are operating adequately and are not obstructed;

If an indirect refrigerating circuit is being used, the secondary circuit shall be checked for the presence of refrigerant; Marking to the equipment continues to be visible and legible. Markings and signs that are illegible shall be corrected;

Refrigeration pipe or components are installed in a position where they are unlikely to be exposed to any substance which may corrode refrigerant containing components, unless the components are constructed of materials which are inherently resistant to being corroded or are suitably protected against being so corroded.

Safety Instructions (Continued)

Information on servicing (Continued)

9. Checks to electrical devices

Repair and maintenance to electrical components shall include initial safety checks and component inspection procedures. If a fault exists that could compromise safety, then no electrical supply shall be connected to the circuit until it is satisfactorily dealt with. If the fault cannot be corrected immediately but it is necessary to continue operation, an adequate temporary solution shall be used. This shall be reported to the owner of the equipment so all parties are advised.

Initial safety checks shall include:

That capacitors are discharged: this shall be done in a safe manner to avoid possibility of sparking;

That there no live electrical components and wiring are exposed while charging, recovering or purging the system; That there is continuity of earth bonding.

10. Repairs to sealed components

- During repairs to sealed components, all electrical supplies shall be disconnected from the equipment being worked upon prior to any removal of sealed covers, etc. If it is absolutely necessary to have an electrical supply to equipment during servicing, then a permanently operating form of leak detection shall be located at the most critical point to warn of a potentially hazardous situation.
- Particular attention shall be paid to the following to ensure that by working on electrical components, the casing is not altered in such a way that the level of protection is affected. This shall include damage to cables, excessive number of connections, terminals not made to original specification, damage to seals, incorrect fitting of glands, etc. Ensure that apparatus is mounted securely. Ensure that seals or sealing materials have not degraded such that they no longer serve the purpose of preventing the ingress of flammable atmospheres. Replacement parts shall be in accordance with the manufacturer's specifications.
NOTE: The use of silicon sealant may inhibit the effectiveness of some types of leak detection equipment. Intrinsically safe components do not have to be isolated prior to working on them.

11. Repair to intrinsically safe components

Do not apply any permanent inductive or capacitance loads to the circuit without ensuring that this will not exceed the permissible voltage and current permitted for the equipment in use. Intrinsically safe components are the only types that can be worked on while live in the presence of a flammable atmosphere. The test apparatus shall be at the correct rating. Replace components only with parts specified by the manufacturer. Other parts may result in the ignition of refrigerant in the atmosphere from a leak.

12. Cabling

Check that cabling will not be subject to wear, corrosion, excessive pressure, vibration, sharp edges or any other adverse environmental effects. The check shall also take into account the effects of aging or continual vibration from sources such as compressors or fans.

13. Detection of flammable refrigerants

Under no circumstances shall potential sources of ignition be used in the searching for or detection of refrigerant leaks. A halide torch (or any other detector using a naked flame) shall not be used.

14. Leak detection methods

The following leak detection methods are deemed acceptable for systems containing flammable refrigerants. Electronic leak detectors shall be used to detect flammable refrigerants, but the sensitivity may not be adequate, or may need re-calibration. (Detection equipment shall be calibrated in a refrigerant-free area.) Ensure that the detector is not a potential source of ignition and is suitable for the refrigerant used. Leak detection equipment shall be set at a percentage of the LFL of the refrigerant and shall be calibrated to the refrigerant employed and the appropriate percentage of gas (25 % maximum) is confirmed. Leak detection fluids are suitable for use with most refrigerants but the use of detergents containing chlorine shall be avoided as the chlorine may react with the refrigerant and corrode the copper pipe-work. If a leak is suspected, all naked flames shall be removed/extinguished. If a leakage of refrigerant is found which requires brazing, all of the refrigerant shall be recovered from the system, or isolated (by means of shut off valves) in a part of the system remote from the leak. Oxygen free nitrogen (OFN) shall then be purged through the system both before and during the brazing process.

15. Removal and evacuation

When breaking into the refrigerant circuit to make repairs or for any other purpose conventional procedures shall be used. However, it is important that best practice is followed since flammability is a consideration. The following procedure shall be adhered to:

Remove refrigerant; Purge the circuit with inert gas; Evacuate; Purge again with inert gas; Open the circuit by cutting or brazing.

The refrigerant charge shall be recovered into the correct recovery cylinders. The system shall be flushed with OFN to render the unit safe. This process may need to be repeated several times. Compressed air or oxygen shall not be used for this task. Flushing shall be achieved by breaking the vacuum in the system with OFN and continuing to fill until the working pressure is achieved, then venting to atmosphere,

and finally pulling down to a vacuum. This process shall be repeated until no refrigerant is within the system. When the final OFN charge is used, the system shall be vented down to atmospheric pressure to enable work to take place. This operation is absolutely vital if brazing operations on the pipe-work are to take place. Ensure that the outlet for the vacuum pump is not close to any ignition sources and there is ventilation available.

16. Charging procedures

In addition to conventional charging procedures, the following requirements shall be followed. Ensure that contamination of different refrigerants does not occur when using charging equipment. Hoses or lines shall be as short as possible to minimise the amount of refrigerant contained in them. Cylinders shall be kept upright. Ensure that the refrigeration system is earthed prior to charging the system with refrigerant. Label the system when charging is complete (if not already). Extreme care shall be taken not to overfill the refrigeration system. Prior to recharging the system it shall be pressure tested with OFN. The system shall be leak tested on completion of charging but prior to commissioning. A follow up leak test shall be carried out prior to leaving the site.

17. Decommissioning

Before carrying out this procedure, it is essential that the technician is completely familiar with the equipment and all its detail. It is recommended good practice that all refrigerants are recovered safely. Prior to the task being carried out, an oil and refrigerant sample shall be taken in case analysis is required prior to re-use of reclaimed refrigerant. It is essential that electrical power is available before the task is commenced.

- a. Become familiar with the equipment and its operation.
- b. Isolate system electrically.
- c. Before attempting the procedure ensure that:
Mechanical handling equipment is available, if required, for handling refrigerant cylinders; All personal protective equipment is available and being used correctly; The recovery process is supervised at all times by a competent person; Recovery equipment and cylinders conform to the appropriate standards.
- d. Pump down refrigerant system, if possible.
- e. If a vacuum is not possible, make a manifold so that refrigerant can be removed from various parts of the system.
- f. Make sure that cylinder is situated on the scales before recovery takes place.
- g. Start the recovery machine and operate in accordance with manufacturer's instructions.
- h. Do not overfill cylinders. (No more than 80 % volume

liquid charge).

- i. Do not exceed the maximum working pressure of the cylinder, even temporarily.
- j. When the cylinders have been filled correctly and the process completed, make sure that the cylinders and the equipment are removed from site promptly and all isolation valves on the equipment are closed off.
- k. Recovered refrigerant shall not be charged into another refrigeration system unless it has been cleaned and checked.

18. Labelling

Equipment shall be labelled stating that it has been de-commissioned and emptied of refrigerant. The label shall be dated and signed. Ensure that there are labels on the equipment stating the equipment contains flammable refrigerant.

19. Recovery

When removing refrigerant from a system, either for servicing or decommissioning, it is recommended good practice that all refrigerants are removed safely. When transferring refrigerant into cylinders, ensure that only appropriate refrigerant recovery cylinders are employed. Ensure that the correct number of cylinders for holding the total system charge is available. All cylinders to be used are designated for the recovered refrigerant and labelled for that refrigerant (i.e. special cylinders for the recovery of refrigerant). Cylinders shall be complete with pressure relief valve and associated shut-off valves in good working order. Empty recovery cylinders are evacuated and, if possible, cooled before recovery occurs. The recovery equipment shall be in good working order with a set of instructions concerning the equipment that is at hand and shall be suitable for the recovery of flammable refrigerants. In addition, a set of calibrated weighing scales shall be available and in good working order. Hoses shall be complete with leak-free disconnect couplings and in good condition. Before using the recovery machine, check that it is in satisfactory working order, has been properly maintained and that any associated electrical components are sealed to prevent ignition in the event of a refrigerant release. Consult manufacturer if in doubt. The recovered refrigerant shall be returned to the refrigerant supplier in the correct recovery cylinder, and the relevant Waste Transfer Note arranged. Do not mix refrigerants in recovery units and especially not in cylinders. If compressors or compressor oils are to be removed, ensure that they have been evacuated to an acceptable level to make certain that flammable refrigerant does not remain within the lubricant. The evacuation process shall be carried out prior to returning the compressor to the suppliers. Only electric heating to the compressor body shall be employed to accelerate this process. When oil is drained from a system, it shall be carried out safely

Your Portable Air-conditioner

FRONT
IAP2740W

FRONT
IAP3000W & IAP3800W

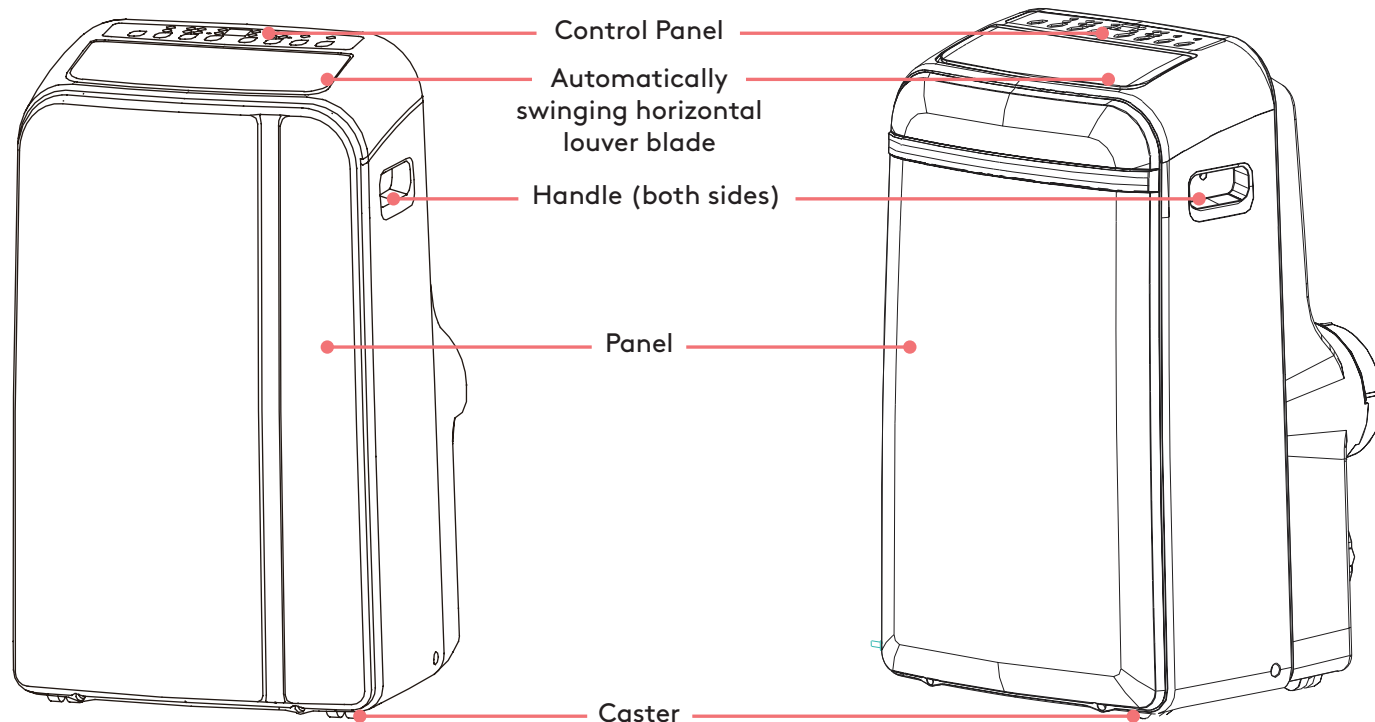



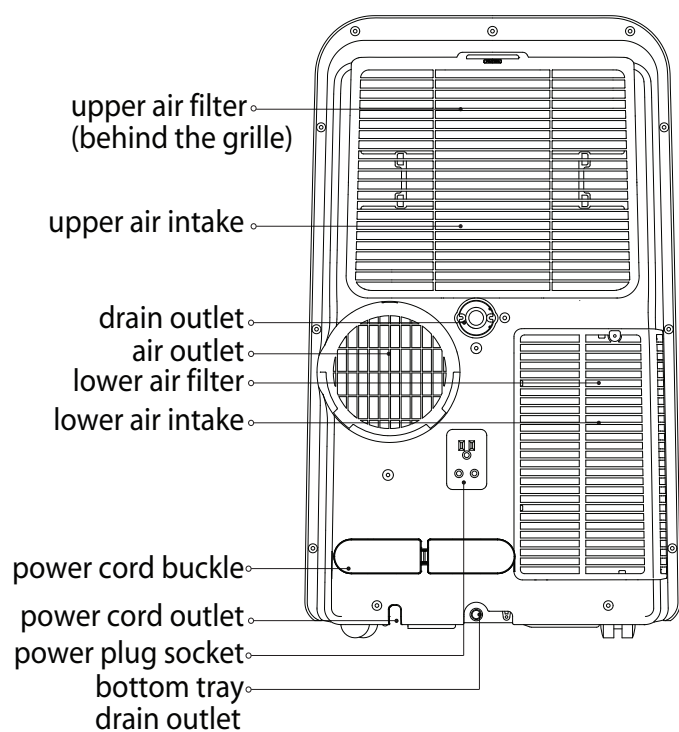



REAR

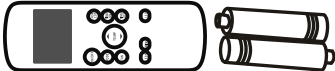

NOTE: All illustrations in this manual are for explanation purposes only. Your unit may appear differently.

ACCESSORIES

Shape	Name of Accessories	Quantity
	Exhaust Hose	1 piece
	Window Slider Adaptor	1 piece (*)
	Window Slider A	1 piece (*)
	Window Slider B	1 piece (*)
	Bolt	1 piece (*)
	Remote Controller and Batteries	1 set (*)
	Exhaust Hose Adaptor	1 piece (*)

NOTE: Items with (*) are on some models. Slight variations in design may occur.

Installation

Consider the following for optimal performance:

- Make sure that no furniture or other objects are obstructing airflow.
- Keep the filter clean.
- Shut any curtains in any room exposed to direct sunlight to prevent the room from becoming unnecessarily warm.
- Keep all doors and windows closed to prevent warm air from entering the room.
- The cooling function of the air conditioner works best in rooms with an ambient temperature of 17–35°C.
- The dehumidifying function of the air conditioner works best in rooms with an ambient temperature of 13–35°C.

UNPACKING

- This product has been packaged to protect it against transportation damage. Unpack the appliance and keep the original packaging carton and materials in a safe place. It will help prevent any damage if the product needs to be transported in the future, and you can use it to store the appliance when it is not in use. In the event the carton is to be disposed of, please recycle all packaging materials where possible.
- Plastic wrapping can be a suffocation hazard for babies and young children, so ensure all packaging materials are kept out of their reach and disposed of safely.
- Unwind the cord fully and inspect it for damage. Do not use if any part is damaged. In case of damage, contact our after sales support line for advice.
- Read the manual to familiarise yourself with all parts and operating principles. Pay particular attention to the safety instructions on the previous pages.

WARNING! ELECTRIC SHOCK HAZARD!

Before installation or servicing, ensure the unit is switched off and disconnected from the power outlet to prevent possible injury.

LOCATION

When deciding on an installation place, keep the following points in mind:

- The area must be flat and the air outlets must not be covered up.
- There must be a properly earthed AC 220~240V 50Hz power point nearby.
- The air exhaust can be installed in a vertical or horizontal sliding window. Window installation instructions follow on the next pages.
- There must be a clearance of at least 30cm between the appliance and the wall or any other obstacles. Maintaining this 30cm clearance is essential; failure to keep that distance can result in the unit malfunctioning or causing injury.

IMPORTANT NOTE: Do not install this appliance at a dry cleaner's premises.

TOOLS REQUIRED

- Medium Philips screwdriver
- Tape measure or ruler
- Knife or scissors
- Optional: Saw, to shorted window adaptor for narrow windows (Window Installation Kit suits windows 67.5–123cm)

Installation, service, maintenance and repair of this unit must be performed by a certified technician.

INSTALLING THE AIR EXHAUST DUCT

The portable air conditioner window kit comes with the parts shown on page 11.

Note:

- The exhaust hose should be used when the COOL or AUTO functions are selected in order to divert warm exhaust air.
- The exhaust hose does not need to be mounted when the FAN or DRY functions are used.
- The exhaust hose can be mounted in a window or a simple temporary set up can be used to prop up the exhaust hose to discharge the excess warm exhaust air.

NOTE: All illustrations in this manual are for explanation purposes only. Your unit may appear differently.

WINDOW KIT ASSEMBLY

1. Press exhaust hose into window slider adaptor.

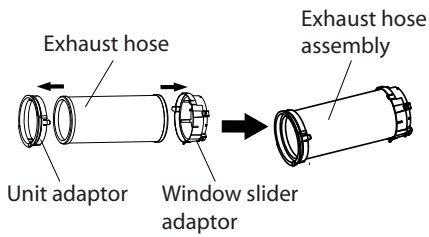

2. Install exhaust hose assembly to unit.

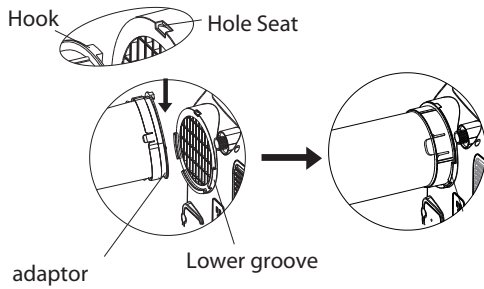

3. Adjust window slider to required size according to your window.

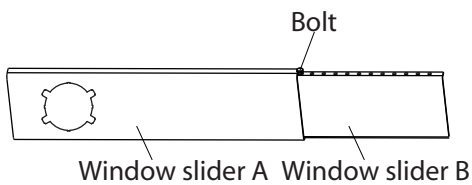

WINDOW KIT INSTALLATION

Attach the window kit to the window stool. Adjust the length of the window slider kit according to the width of the window.

Open the window and place the window slider kit on the window stool.

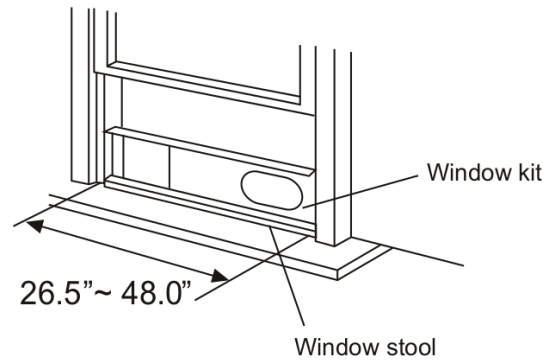

Close the window securely against the window kit. Vertically-sliding windows (pictured) and horizontally-sliding windows will function similarly.

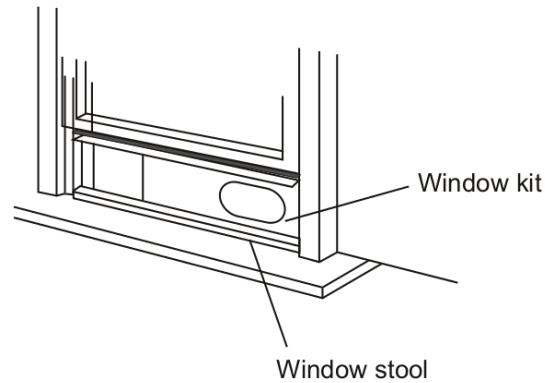

Getting Started

CONTROL PANEL

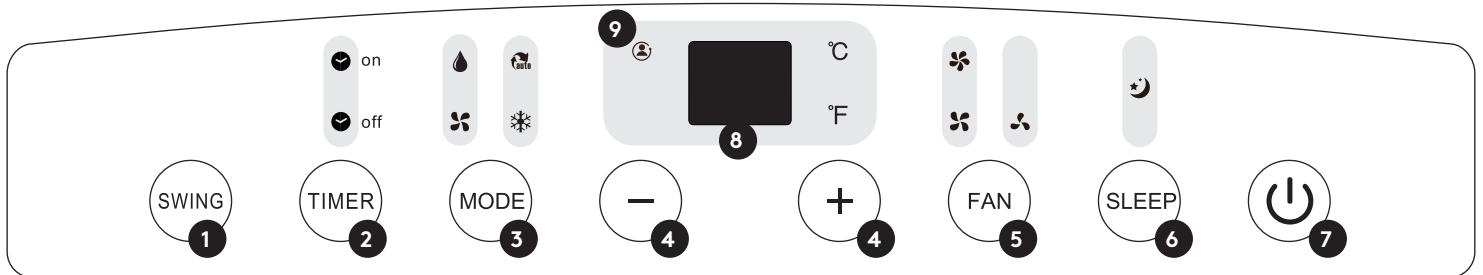

1. **Swing:** Initiate the auto swing feature. Press again to halt at current angle.
2. **Timer:** Used to initiate the AUTO ON start time and AUTO OFF stop time program, in conjunction with the + & - buttons. The timer on/off indicator light illuminates under the timer on/off settings.
3. **Mode:** Selects the appropriate operating mode. Each time you press the button, a mode is selected in a sequence that goes from AUTO, COOL, DRY, FAN and HEAT (cooling only models do not include Heat). The mode indicator light illuminates under the different mode settings.
4. **Up (+) and Down (-):** Adjust temperature or time settings.
5. **Fan:** Set fan speed to LOW, MID, HIGH or AUTO. The fan speed indicator light illuminates under different fan settings except AUTO speed, where no indicators are illuminated.
6. **Sleep (Eco):** Initiate sleep/eco option.
7. **[⏻] Power:** Turn the unit on or off.
8. **LED Screen:** Displays temperature and timer settings. On DRY and FAN models shows room temperature. Displays error codes (see Troubleshooting page 18).
9. **Follow Me (not available on all models):** Allows the remote to measure the temperature at its current location, adjusting the temperature for maximum comfort.

REMOTE CONTROL

10. **ON/OFF:** On/off switch
11. **MODE (Select function):** (Auto, Air conditioner (Cool), fan (Fan) or dehumidifier (Dry))
12. **FAN:** Fan speed setting low/high
13. **▲TEMP▼:** Temperature setting
14. **SHORTCUT:** Go back to current or previous setting.
15. **TIMER ON:** Setting for when the timer is to switch the air conditioner on
16. **TIMER OFF:** Setting for when the timer is to switch the air conditioner off
17. **SLEEP:** Gradual lowering of room temperature, for example before going to bed
18. **SWING:** Initiates the auto swing feature
19. **FOLLOW ME (not all models):** Allows the remote to measure the temperature at its current location, adjusting the temperature for maximum comfort.
20. **LED:** Switch the LED display on/off

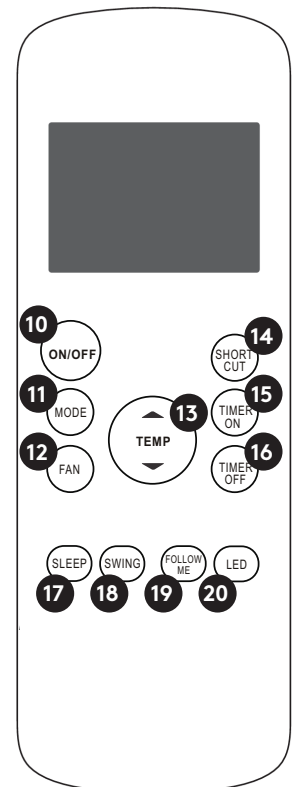

NOTE: All illustrations in this manual are for explanation purposes only. Your unit may appear differently.

Note: The included remote control is a universal type which is used for several different models. This model of air conditioner and the included remote control differ from other types in the following two ways:

1. The remote control has an "Auto" mode which the main unit does not have. If "Auto" is selected using the remote control, the main unit will be set to "Cool" mode but without the option of selecting the fan speed.
2. The remote control has 3 settings for the fan speed: Low, high and "Auto". The "Auto" fan speed setting does not work with this model of air conditioner. There are in effect only 2 fan speed settings, low and high.

INSERTING BATTERIES INTO THE REMOTE CONTROL

1. Remove the battery cover on the back of the remote control by sliding it in the direction of the arrow.
2. Insert 2 x AAA batteries (included). Note the polarity markings in the battery compartment to ensure correct insertion.
3. Slide the battery cover back into place.

REMOTE CONTROL DISPLAY

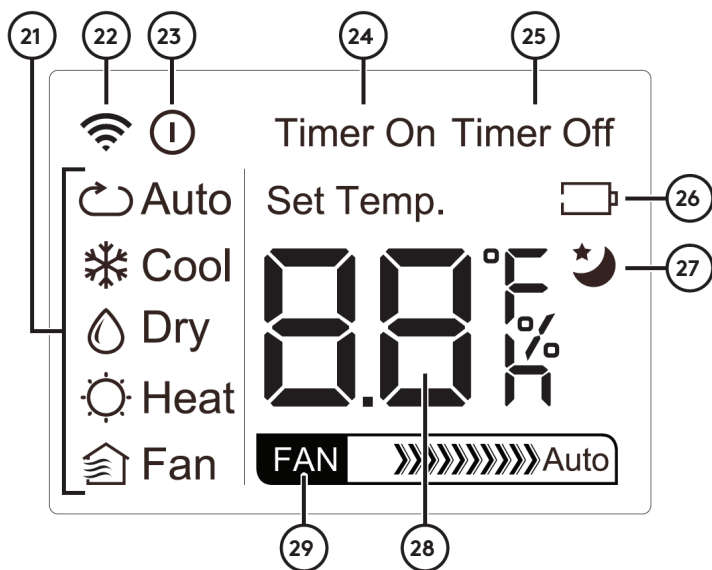

21. Displayed functions.
22. Shown when the remote control transmits a signal.
23. Shown when the air conditioner is switched on.
24. Shown when the Timer On mode is activated.
25. Shown when the Timer Off mode is activated.
26. Shown when the remote control batteries need changing.
27. Shown when the sleep mode is activated.
28. Shows the chosen fan speed.
29. Shows the chosen temperature or timer setting. In fan mode nothing is shown on the display.

Operation Instructions

Note:

- The air conditioner should be placed on a firm, level surface capable of supporting its weight.
- Make sure to keep at least 30 cm of free space around the air conditioner.
- The wheels are fitted to facilitate movement over flat surfaces. Never try to roll the air conditioner over uneven or soft surfaces.
- If the air conditioner should be shut off inadvertently e.g. by a power cut, it will restart automatically with the same settings it had before the power cut when the power comes back on.
- The remote control has an 8-metre range. Point the remote directly at the air conditioner making sure that there is no furniture or other objects obstructing the signals from reaching the air conditioner.
- The signals from the remote can be blocked if the IR sensor on the air conditioner is exposed to strong sunlight.
- Do not expose the remote control to strong sunlight, impacts, shocks or wetting
- Before switching the unit on for the first time, make sure you have properly installed the exhaust hose and inserted batteries into the remote control.
- Plug the portable air conditioner into a properly earthed 220~240V AC 50Hz mains socket and switch on power to the outlet.

Note: Do not connect it to a multiple socket outlet that is also being used for other electrical appliances. Do not connect it to an extension cord.

CHANGING THE UNITS OF TEMPERATURE, °C OR °F

Using your Remote control, hold in [▲TEMP▼] to switch between units.

USING THE MAIN UNIT

Hold in [+] and [-] simultaneously to switch between units.

THE COOL, DRY AND FAN MODES

- The Cool, Dry and Fan modes can be controlled both from the main unit and using the remote control. The instructions below explain how the modes are controlled from the main unit. In some of the modes, the fan speed can only be set using the remote control (see below).
- If you wish to use the remote control: Press [MODE] on the remote control and set the temperature with [▲TEMP▼].

AIR CONDITIONER MODE (COOL)

1. Switch the air conditioner on.
2. Press [MODE] until the "COOL" indicator lights up.
3. Press [+]/[-] to set the desired temperature, 17–30°C (62–86°F). The display shows the set temperature.
4. Press the "FAN SPEED" button to choose the fan speed.

DEHUMIDIFIER MODE (DRY)

- Press [MODE] until the "Dry" indicator lights up. Note: The temperature and fan speed cannot be set when the dehumidifier mode is activated. The fan motor operates at LOW speed.
- Keep windows and doors closed for best results.
- Do not put the duct to window.

AUTO MODE

When you set the air conditioner in AUTO mode, it will automatically select cooling or fan only operation depending on what temperature you have selected and the room temperature. Under AUTO mode, fan speed cannot be set.

FAN MODE

1. Press [MODE] until the "Fan" indicator lights up.
2. Press the "FAN SPEED" button to choose the fan speed.

Note: The temperature cannot be set when the fan mode is activated. Do not put the duct to window.

TIMER OPERATION

- When the unit is on, press Timer button to initiate Auto-off stop program: TIMER OFF indicator will illuminate. Press Up (+) or Down (-) to select time. Press the TIMER button again within 5 seconds to initiate the Auto-on start program: the TIMER ON indicator will illuminate. Press Up (+) or Down (-) to select Auto-on start time.
- When the unit is off, press the Timer button to initiate Auto-on start program. Press it again within five seconds to initiate the Auto-off stop program.
- Press or hold Up (+) or Down (-) to set the Auto time by 0.5 hour increments up to 10 hours, then at 1 hour increments up to 24 hours. The remaining time will be displayed.
- Turning the unit ON or OFF, adjusting the timer setting to 0.0 or any instance of malfunction will cancel the Auto Start/Stop timer program.

SLEEP/ECO MODE

- The selected temperature will increase by 1°C over 30 minutes. The temperature will then increase by another 1°C after an additional 30 minutes. This new temperature will be maintained for 7 hours before it returns to the originally selected temperature. Sleep/Eco mode will end and the unit will continue to operate as originally programmed.

Note: This feature is unavailable under FAN or DRY mode.

WATER DRAINAGE

- Remove the upper drain plug from the back of the unit and attach 3/4" hose (not included).
- NOTE: Make sure the hose is secure so there are no leaks.
- Direct the hose toward the drain, making sure that there are no kinks. Place the end of the hose into the drain and make sure the end of the hose is down to let the water flow smooth.
- When the water level of the bottom tray is full, the unit will beep 8 times and display "PI". The air conditioning/dehumidification process will immediately stop, while the fan motor continues to operate. Carefully move the unit to a drain location, remove the bottom drain plug and allow the water to drain. Reinstall bottom drain plug and restart the machine until the "PI" symbol disappears.

NOTE: Always install drain plugs and hose firmly to prevent leaking.

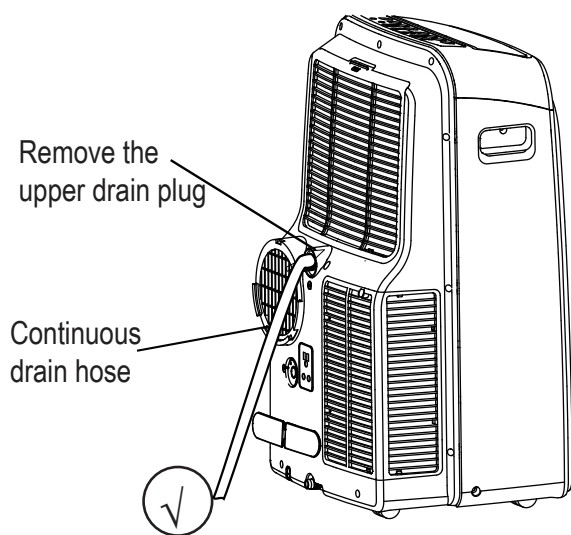

Troubleshooting



If you experience problems with your portable air conditioner, or it appears not to be operating correctly, check the information below for solutions to common problems. If none of the solutions offered help you solve your problem, please contact our after sales support centre on 1300 11 HELP (4357) or emailing support@residentialgroup.com.au for advice. Do not attempt to repair the appliance yourself!

The air conditioner will not start	<ul style="list-style-type: none">• Is it plugged into a wall socket?• Is the wall socket live?• Is the Water Collection Tray is full? Turn off the unit, drain the water from the Water Collection Tray and restart the unit. <p>The room temperature is lower than the set temperature. Adjust the temperature using [▲TEMP▼].</p>
Insufficient cooling	<ul style="list-style-type: none">• Makes sure there are no open windows or doors that are allowing warm air in. Close all windows and doors.• There are other sources of heat present in the room. Turn these off.• The exhaust hose is not attached. See the Connecting the exhaust hose section.• The temperature is set too high. Reduce the temperature.• The air filter is clogged. See 'Care and cleaning' under the Other Useful Information section.
Noise and vibrations occur	Make sure that the air conditioner is placed on a steady, even and level surface.
A gurgling sound is heard	This can often be explained by the movement of the coolant in the air conditioner. This is completely normal.



Technical Data

RATING LABELS



IAP2740W:

2.74kW Portable Air-conditioner			
MODEL: IAP2740W			
INALT?			
COOLING CAPACITY	2.74kW		
HEATING CAPACITY	—		
MAXIMUM ALLOWABLE PRESSURE	2.6MPa		
EXCESSIVE OPERATING PRESSURE	DISCHARGE	2.6MPa	
	SUCTION	1.0MPa	
POWER SOURCE	220-240V~ 50Hz, 1Ph		
REFRIGERANT	R290/0.20kg 		
STANDARD RATING CONDITIONS	COOLING	CURRENT	4.30A
		INPUT	0.98kW
	HEATING	CURRENT	—
		INPUT	—
RATED CURRENT	5.65A		
RATED INPUT	1.16kW		
ELECTRICAL HEATER INPUT	—		
MOISTURE RESISTANCE CLASS	IPX0		
WARNING			
Appliance should be installed, operated and stored in a room with a floor area larger than 10 m ² .			

IAP3000W:

3.0kW Portable Air-conditioner			
MODEL: IAP3000W			
INALT?			
COOLING CAPACITY	3.0kW		
HEATING CAPACITY	—		
MAXIMUM ALLOWABLE PRESSURE	2.6MPa		
EXCESSIVE OPERATING PRESSURE	DISCHARGE	2.6MPa	
	SUCTION	1.0MPa	
POWER SOURCE	220-240V~ 50Hz, 1Ph		
REFRIGERANT	R290/0.20kg 		
STANDARD RATING CONDITIONS	COOLING	CURRENT	4.40A
		INPUT	1.00kW
	HEATING	CURRENT	—
		INPUT	—
RATED CURRENT	6.00A		
RATED INPUT	1.15kW		
ELECTRICAL HEATER INPUT	—		
MOISTURE RESISTANCE CLASS	IPX0		
WARNING			
Appliance should be installed, operated and stored in a room with a floor area larger than 10 m ² .			

IAP3800W:

3.8kW Portable Air-conditioner			
MODEL: IAP3800W			
INALT?			
POWER SOURCE	220-240V~ 50Hz, 1Ph		
COOLING	CAPACITY	3.8kW	
	CURRENT	6.5A	
HEATING	CAPACITY	—	
	CURRENT	—	
MAXIMUM ALLOWABLE PRESSURE	4.2MPa		
EXCESSIVE OPERATING PRESSURE	DISCHARGE	4.2MPa	
	SUCTION	1.5MPa	
REFRIGERANT	R410A/0.46kg		
RATED CURRENT	8.9A		
RATED INPUT	1.76kW		
ELECTRICAL HEATER INPUT	—		
CLIMATE CLASS	T1		
SPLASH PROOF	IPX0 		
MADE IN CHINA			
USE A 25A CIRCUIT BREAKER			
INALT?			

This appliance IAP3800W can be connected only to a supply with system impedance no more than 0.383 Ω. In case necessary, please consult your supply authority for system impedance information.

Other Useful Information

CARE AND CLEANING

WARNING! ELECTRIC SHOCK HAZARD!

Before cleaning and servicing, ensure the unit is switched off and disconnected from the power outlet to prevent possible injury.

- DO NOT use flammable liquids or chemicals to clean the unit.
- DO NOT wash the unit under running water. Doing so poses an electrical hazard.
- Clean the air filter every 2 weeks for optimal performance.
- If PI error occurs (see Troubleshooting p8), drain the water collection tray immediately after PI and before storage to prevent mould forming.
- In households with animals, animal hair can block the airflow: periodically wipe down the grill.
- Store unit in a cool, dark place. Exposure to direct sunshine or extreme heat can shorten the lifespan of the unit.
- Clean the unit using a damp, lint-free cloth and mild detergent. Dry the unit with a dry lint-free cloth.
- Run the appliance on FAN mode for 12 hours in a warm room to dry it and prevent mold.

CAUTION: Do not wash the unit directly. Do not use any solvent or alcohol-based cleaning agent on any surface. Using such harsh cleansers will scratch or damage the surface, or can even lead to deformation of the housing.

BATTERY REPLACEMENT

If the batteries in the remote control are flat, insert two new AAA size batteries in the compartment at the back of the remote control.

Open the cover to the battery compartment at the back of the remote control.

- Take out the depleted batteries (if applicable) and replace them with two fresh batteries of the same size and type (AAA size), making sure to match the polarity markings (+/-) on the batteries with those inside the compartment.

Close the battery compartment.

CLEANING THE AIR FILTERS

The air filter should be cleaned every 14 days.

- Turn off the air conditioner and pull out the plug from the wall socket.
- Allow the filter to completely dry before refitting it.

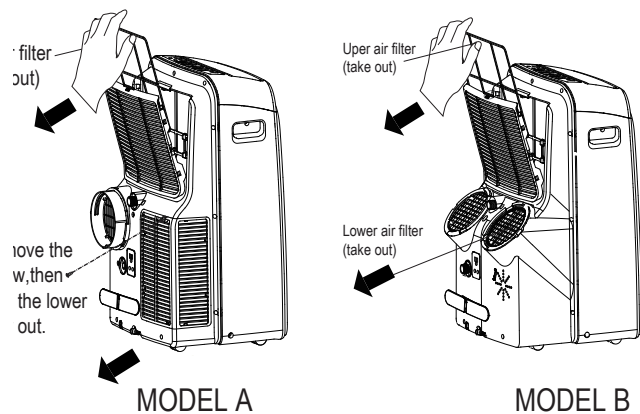

CAUTION

DO NOT operate the unit without filter because dirt and lint will clog it and reduce performance.

BEFORE STORAGE

At the end of the summer season, follow the simple steps below before disconnecting and storing the portable air conditioner. The ambient temperature should be below 23°C.

- Drain the unit's water collection tray according to the instructions in the following section.
- Run the appliance on FAN mode for 12 hours in a warm room to dry it and prevent mold.
- Turn off the appliance and unplug it.
- Clean the air filter according to the instructions in the previous section. Reinstall the clean, dry filter before storing.
- Remove the batteries from the remote control.

Note: Be sure to store the unit in a cool, dark place. Exposure to direct sunshine or extreme heat can shorten the lifespan of the unit.

Note: The cabinet and front may be dusted with an oil-free cloth or washed with a cloth dampened in a solution of warm water and mild liquid dishwashing detergent. Rinse thoroughly and wipe dry. Never use harsh cleansers, wax or polish on the cabinet front. Be sure to wring excess water from the cloth before wiping around the controls. Excess water in or around the controls may cause damage to the unit.

BATTERY PRECAUTIONS

- Do not open batteries or short-circuit batteries. Do not mix old and new, or different types of batteries. Only use fresh batteries of the correct size and type.
- Due to increased risk of leakage, remove batteries when they are empty and when the remote control is not going to be used for long periods.
- **WARNING:** Avoid contact with battery acid! If battery acid has leaked, avoid contact with skin, eyes and mucous membranes to prevent injury. In the event of contact with the acid, rinse the affected areas immediately with plenty of clean water and contact a doctor at once.
- **WARNING:** Keep out of reach of children! Children often cannot assess dangers correctly and are injured as a result. Please therefore ensure that the remote control is kept out of children's reach as it contains batteries. If batteries are swallowed, seek immediate medical assistance. Also ensure the remote control packaging is disposed of safely.
- Only dispose of batteries when they are fully discharged. Dispose of them in accordance with statutory regulations. Do not dispose of them in household waste.
- **WARNING:** Danger of explosion! To prevent a risk of explosion, normal batteries must not be charged, heated or disposed of by burning. Never throw batteries into a fire or subject them to high temperatures.

SERVICE AND REPAIR

If you look after your portable air conditioner it should give you years of good service. Should you experience problems with the appliance that you cannot solve yourself using the advice given within this manual, please contact our after sales support centre for advice.

WARNING!

Do not attempt to repair the appliance yourself!

SPARE PARTS

Our after sales support centre stocks spare parts for this Portable Air Conditioner. To purchase a part, call the centre on 1300 11 4357.

COMPLIANCE

This appliance has been fully tested and meets all requirements as set out by standards AS/NZS 60335.1 and AS/NZS 60335.2.40.

RESPONSIBLE DISPOSAL

At the end of its working life, do not throw this appliance out with your household rubbish. Electrical and electronic products contain substances that can have a detrimental effect on the environment and human health if disposed of inappropriately. Observe any local regulations regarding the disposal of electrical consumer goods and dispose of it appropriately for recycling and recovery of the refrigerant. Contact your local authorities for advice on recycling facilities in your area.



Attach your receipt
to this page



Purchase Details

For future reference, please record the following information which can be found on the rating plate and the date of purchase which can be found on your sales invoice.

STORE DETAILS

STORE NAME |

ADDRESS |

TELEPHONE |

PURCHASE DATE |

PRODUCT DETAILS

MODEL NO. |

SERIAL NO.* |

Warranty Information

AUSTRALIAN WARRANTY TERMS & CONDITIONS

AIR CONDITIONING

This document sets out the terms and conditions of the product warranties for Residentia Group Appliances. It is an important document. Please keep it with your proof of purchase documents in a safe place for future reference should you require service for your Appliance.

1. IN THIS WARRANTY

- (a) 'acceptable quality' as referred to in clause 10 of this warranty has the same meaning referred to in the ACL;
 - (b) 'ACL' means Trade Practices Amendment (Australian Consumer Law) Act (No.2) 2010;
 - (c) 'Appliance' means any Residentia Group product purchased by you accompanied by this document;
 - (d) 'ASR' means Residentia Group authorised service representative;
 - (e) 'Residentia Group' means Residentia Group Pty Ltd of 165 Barkly Avenue Burnley VIC, ACN 600 546 656 in respect of Appliances purchased in Australia;
 - (f) 'major failure' as referred to in clause 10 of this warranty has the same meaning referred to in the ACL and includes a situation when an Appliance cannot be repaired or it is uneconomic for Residentia Group, at its discretion, to repair an Appliance during the Warranty Period;
 - (g) 'Warranty Period' means:
 - (i) where the Appliance is used for personal, domestic or household use (i.e. normal single family use) as set out in the instruction manual, the Appliance is warranted against manufacturing defects for 36 months, following the date of original purchase of the Appliance;
 - (h) 'you' means the purchaser of the Appliance not having purchased the Appliance for re-sale, and 'your' has a corresponding meaning.
2. This warranty only applies to Appliances purchased and used in Australia and is in addition to (and does not exclude, restrict, or modify in any way) any non-excludable statutory warranties in Australia.
 3. During the Warranty Period Residentia Group or its ASR will, at no extra charge if your Appliance is readily accessible for service, without special equipment and subject to these terms and conditions, repair or replace any parts which it considers to be defective. Residentia Group or its ASR may use remanufactured parts to repair your Appliance. You agree that any replaced Appliances or parts become the property of Residentia Group. This warranty does not apply to light globes, batteries, filters or similar perishable parts.
 4. Parts and Appliances not supplied by Residentia Group are not covered by this warranty.
 5. You will bear the cost of transportation, travel and delivery of the Appliance to and from Residentia Group or its ASR. If you reside outside of the service area, you will bear the cost of:
 - (a) travel of an authorised representative;
 - (b) transportation and delivery of the Appliance to and from Residentia Group or its ASR, in all instances, unless the Appliance is transported by Residentia Group or its ASR, the Appliance is transported at the owner's cost and risk while in transit to and from Residentia Group or its ASR.
 6. Proof of purchase is required before you can make a claim under this warranty.
 7. You may not make a claim under this warranty unless the defect claimed is due to faulty or defective parts or workmanship. Residentia Group is not liable in the following situations (which are not exhaustive):

-
- (a) the Appliance is damaged by:
- (i) accident
 - (ii) misuse or abuse, including failure to properly maintain or service
 - (iii) normal wear and tear
 - (iv) power surges, electrical storm damage or incorrect power supply
 - (v) incomplete or improper installation
 - (vi) incorrect, improper or inappropriate operation
 - (vii) insect or vermin infestation
 - (viii) failure to comply with any additional instructions supplied with the Appliance;
- (b) the Appliance is modified without authority from Residentia Group in writing;
- (c) the Appliance's serial number or warranty seal has been removed or defaced;
- (d) the Appliance was serviced or repaired by anyone other than Residentia Group, an authorised repairer or ASR.
8. This warranty, the contract to which it relates and the relationship between you and Residentia Group are governed by the law applicable where the Appliance was purchased.
9. To the extent permitted by law, Residentia Group excludes all warranties and liabilities (other than as contained in this document) including liability for any loss or damage whether direct or indirect arising from your purchase, use or non use of the Appliance.
10. For Appliances and services provided by Residentia Group in Australia, the Appliances come with a guarantee by Residentia Group that cannot be excluded under the Australian Consumer Law. You are entitled to a replacement or refund for a major failure and for compensation for any other reasonably foreseeable loss or damage. You are also entitled to have the Appliance repaired or replaced if the Appliance fails to be of acceptable quality and the failure does not amount to a major failure. The benefits to you given by this warranty are in addition to your other rights and remedies under a law in relation to the Appliances or services to which the warranty relates.
11. At all times during the Warranty Period, Residentia Group shall, at its discretion, determine whether repair, replacement or refund will apply if an Appliance has a valid warranty claim applicable to it.
12. To enquire about claiming under this warranty, please follow these steps:
- (a) carefully check the operating instructions, user manual and the terms of this warranty;
 - (b) have the model and serial number of the Appliance available;
 - (c) have the proof of purchase (e.g. an invoice) available;
 - (d) telephone the numbers shown below.
13. You accept that if you make a warranty claim, Residentia Group and its ASR may exchange information in relation to you to enable Residentia Group to meet its obligations under this warranty.

IMPORTANT

Before calling for service, please ensure that the steps in point 12 have been followed.

Telephone contact

- ▶ Service: Please call 1300 11 HELP (4357)

The Australian Consumer Law requires the inclusion of the following statement with this warranty:
 Our goods come with guarantees that cannot be excluded under the Australian Consumer Law. You are entitled to a replacement or refund for a major failure and for compensation for any other reasonably foreseeable loss or damage. You are also entitled to have the goods repaired or replaced if the goods fail to be of acceptable quality and the failure does not amount to a major failure.

THIS PAGE IS INTENTIONALLY LEFT BLANK

Warranty Information

NEW ZEALAND WARRANTY TERMS & CONDITIONS AIR-CONDITIONING

To help care for your investment, be sure to register your appliance online. Registration will help you if you need to arrange service in the future, and serves as a record of your purchase – including critical information like model number and serial number – that you can refer to at any time.

Simply visit the below website, or ask your retailer for help: www.inalto.co.nz/register

WARRANTY:

These products are covered by a warranty for a period of 24 months from the date of purchase, subject to the following conditions*. The warranty covers rectification free of charge of any fault arising from defective materials or components, or faulty workmanship or assembly.

* The conditions above mentioned are:

1. That the purchaser carefully follows all instructions packed with the product;
2. That the purchaser and/or installer carefully follows the installation instructions provided and complies with electrical wiring regulations, gas and/or plumbing codes;
3. That the purchaser carefully follows instructions provided in the owner's handbook relating to the proper use and care of the product and does not use the product for any purpose other than the domestic use for which it has been designed;
4. Commercial use of the product for professional or industrial purposes will void this warranty.;
5. That the product was purchased and installed in New Zealand;
6. That this warranty does not extend to:
 - a) optional glass lids for hobs apart from claims which relate to mechanical or physical damage thereof at the date of purchase;
 - b) 'consumable' parts such as light bulbs or filters;
 - c) damage to ceramic glass caused by liquid or solid spill-overs, lack of maintenance, or impact;
 - d) damage to surface coatings caused by cleaning or maintenance using products not recommended by the owner's handbook;
 - e) defects caused by normal wear and tear, accident, negligence, alteration, misuse or incorrect installations;
 - f) a product dismantled, repaired or serviced by any serviceman other than an authorised service agent;

- g) a product not in possession of the original purchaser;
- h) damage caused by power outages or surges
- i) damage caused by pests (eg. rats, cockroaches etc.)

7. That if the product is a freestanding microwave oven or small appliance it must be returned to the dealer/retailer for servicing. These products, unless stated otherwise, have a 12 month warranty from original date of purchase with 24 months on the microwave magnetron; Waste disposers have a 12 month warranty.
8. The provision of service under this warranty is limited by a 25km boundary from the retailer where the product was purchased except for microwaves. Such travelling outside of these limits will incur commercial cost to be paid by you, regulated by the number of kilometres travelled beyond the 25km limit (50km return trip). Microwaves are to be delivered to the nearest authorised service agent by the customer.

Please refer to your user manual for any further conditions that may apply to your specific model.

Nothing herein contained shall be construed in any way as excluding or limiting your rights under the Consumer Guarantees Acts 1993.

For Service please visit www.applico.co.nz/service or contact the dealer/retailer from whom you purchased the product from or call the 0800 number listed below. If you are unable to establish the date of purchase, or the fault is not covered by this warranty, or if the product is found to be in working order, you will be required to bear all service call charges.

Registration of this warranty constitutes acceptance of the terms and conditions of this warranty.

Should you require any assistance, please call Customer Services on 0800 763 448.

Distributed by Applico Ltd.
www.applico.co.nz
July 2019

After registering your appliance online, we recommend you fill out the below information for your reference and keep this warranty card in a safe place.

THIS WARRANTY IS VALID IN NEW ZEALAND ONLY.

A HIGHER LEVEL

INALTO?

OF LIVING

WWW.INALTO.HOUSE



E2447