

USER MANUAL

INALTO[®]

INALTO.HOUSE

Outdoor Beverage Centre 190 Litres

MODEL CODE/S

IBF190



A HIGHER LEVEL OF REFRIGERATION

V2 | 0521

Welcome!

Residentia Group Pty Ltd

ACN. 600 546 656
165 Barkly Avenue
Burnley, Victoria 3121
Australia

—

Applico Ltd

635 Great South Road
Penrose, Auckland 1061
New Zealand

—

InAlto

www.inalto.house

 /inalto.house

 /inalto.house

Congratulations on purchasing your new appliance.

The InAlto brand is proudly distributed within Australia by Residentia Group Pty Ltd.

Please refer to the warranty card at the rear of this manual for information regarding your product's parts and labour warranty, or visit us online at www.residentia.group

At Residentia Group, we are customer obsessed and our Support Team are there to ensure you get the most out of your appliance. Should you want to learn more about the various features of your appliance, and importantly taking care of it when cleaning, our Support Team are here to help. You can use our online Support Centre at anytime by visiting: <http://support.residentiaigroup.com.au>

You can contact us via calling us on 1300 11 HELP (4357)
Or email us at: support@residentiaigroup.com.au

It is important that you read through the following use and care manual thoroughly to familiarise yourself with the installation and operation requirements of your appliance to ensure optimum performance.

Again, thank you for choosing an InAlto appliance and we look forward to being of service to you.

Kind Regards,
The Residentia Team



**A RESIDENTIA
GROUP INITIATIVE**

Contents

General Safety Instructions	4
Product Overview	6
Getting Started	8
Installation	9
Specifications	11
Instructions	12
FAQs & Troubleshooting	14
Other Useful Information	15
Warranty Information	18

Customer Care

InAlto recommends the use of original spare parts. When contacting our customer service team, please ensure that you have the following information at hand (which can be found on your appliances' rating plate).

- Model Number
- Serial Number

T. 1300 11 4357 | E. support@residentiagroup.com.au

General Safety Instructions

IMPORTANT SAFETY INSTRUCTIONS READ CAREFULLY AND KEEP FOR FUTURE REFERENCE

Read this manual thoroughly before first use, even if you are familiar with this type of product. The safety precautions enclosed herein reduce the risk of fire, electric shock and injury when correctly adhered to. Make sure you understand all instructions and warnings.

Keep the manual in a safe place for future reference, along with the completed warranty card and purchase receipt. If you sell or transfer ownership of this product, pass on these instructions to the new owner.

Always follow basic safety precautions and accident prevention measures when using an electrical appliance, including the following:

WARNING: This is a Beverage Centre, this is not intended to be used to preserve or store fresh food or consumables.

A Beverage Centre is designed for the storage of cans/bottles at a set temperature that is particularly suitable for the drinks. The temperature maintained in this Beverage Centre is too high for safe storage of perishable foods.

Electrical Safety

- **Voltage:** Before connecting and turning on the Beverage Centre, ensure the electrical voltage and circuit frequency correspond to that indicated on the appliance rating label.
- **Earthing:** This Beverage Centre should be properly earthed for your safety. The power cord of this Beverage Centre is equipped with a three-prong plug for use in standard wall outlets to minimise the possibility of electrical shock. Do not modify the cord and/or plug provided with the appliance. Improper use of the earthed plug can result in the risk of electric shock.
- **Connection:** This Beverage Centre requires a standard 220-240 V AC 50Hz electrical outlet. Do not overload the electrical circuit.

- **Power cord:** Do not kink or damage the power cord; do not leave it exposed or dangling. Secure it at the back of the appliance so no one steps on or places anything on the cord or against it. Keep the cord out of reach of children. When moving the appliance, make sure not to damage the power cord.
- **Auxiliary Items:** Do not use an inverter, adaptor or extension cord with this Beverage Centre. If the cord is too short, have a qualified electrician install an outlet near the appliance. Use of an extension cord and an inverter can negatively affect the performance of the unit.
- **Protect from moisture:** To protect against the risk of electric shock, do not immerse the unit, cord or plug in water or spray it with any other liquid. Do not connect or disconnect the electric plug when your hands are wet. Turn the power switch off before removing the plug from the socket.
- **WARNING: Disconnect!** To reduce the risk of fire, electric shock or personal injury, always unplug the appliance from the socket when not in use, when moving and before cleaning or servicing. Never unplug the unit by pulling the power cord. Always grip the plug firmly and pull straight out from the power point.
- **Electrical work:** Any electrical work required for the installation of this appliance should be carried out by a qualified electrician.

Usage Conditions and Restrictions

- **Domestic use only:** This Beverage Centre is intended for indoor or outdoor household use only. It is not intended for commercial or industrial use.
- **Purpose:** Do not use this Beverage Centre for anything other than its intended purpose. Other uses are not recommended and may cause fire, electric shock or personal injury.
- **Attachments:** The use of attachments is not recommended by the appliance manufacturer and distributor as they may be hazardous.
- **Improper use:** Damage due to improper use, or repairs made by unqualified personnel will void your warranty. We assume no liability for any eventual damages caused by misuse of the product or noncompliance with these instructions.



- **WARNING:** Do not use mechanical devices or other means to accelerate the defrosting process, other than those recommended by the manufacturer.
- **Usage restriction:** This Beverage Centre is not intended for use by persons (including children) with reduced physical, sensory or mental capabilities, or lack of experience and knowledge, unless they have been given supervision or instructions concerning use of the appliance by a person responsible for their safety.
- **Children:** Supervise young children to ensure they do not play with the appliance. Never allow children to operate, play with or crawl inside the Beverage Centre.
- **WARNING:** Do not use electrical appliances inside the Beverage Centre, unless they are of the type recommended by the manufacturer.
- **Explosive or flammable substances:** Do not store explosive substances such as aerosol cans with a flammable propellant in this Beverage Centre. Do not store or use petrol or any other flammable vapours and liquids in the vicinity of this or any other appliance. Do not use such substances for cleaning the Beverage Centre. The fumes can create a fire hazard or an explosion.
- **Damage:** Do not use the Beverage Centre if the power cord, plug or the Beverage Centre itself is damaged. If the cord is damaged, contact the after sales support line and have the cord replaced by qualified personnel in order to avoid a hazard.
- **WARNING:** Do not damage the refrigerant circuit.
- **Do not modify:** Do not attempt to alter or modify this Beverage Centre in any way.
- **Repair:** Do not attempt to repair or replace any part of your Beverage Centre unless it is specifically recommended in this manual. All other servicing should be referred to a qualified technician. Contact the after sales support line for advice.
- **WARNING:** Keep ventilation openings, in the Beverage Centre enclosure or in-built structure, clear of obstruction.

This symbol alerts you to take care as this Beverage Centre contains a flammable refrigerant (isobutane) and insulation blowing gas (cyclopentane). Do not expose it to high heat, sparks and open flames.

The refrigerant isobutane (R600a) is contained within the refrigerant circuit of the appliance, a gas with a high level of environmental compatibility, which is nevertheless flammable. During transportation and installation of the Beverage Centre, ensure that none of the components of the refrigerant circuit become damaged.

Never use a Beverage Centre with a damaged refrigerant circuit! If the coolant circuit becomes damaged, avoid proximity to open fires and all types of heat sources. The room in which the unit is located should be ventilated for a few minutes.

The room for installing the appliance must be at least 1m³ per 8g of refrigerant. The amount and type of refrigerant in the appliance can be found in the technical specifications on page 18 and on the appliance rating plate.

It is hazardous for anyone other than an Authorised Service Person to service this appliance. In Queensland the authorized Service Person MUST hold a Gas Work Authorisation for hydrocarbon refrigerants, to carry out Servicing or repairs which involve the removal of covers.

Note: If using the Beverage Centre outside in an alfresco area ensure that it is directly connected to an outdoor power point and please ensure it is not left in the weather or in direct sunlight. All electrical connections are to be made in a dry area and outdoor power points must be weatherproof and installed by a qualified electrician. The appliance must not be exposed to rain.



CAUTION
RISK OF FIRE

Product Overview

190L Outdoor Beverage Centre

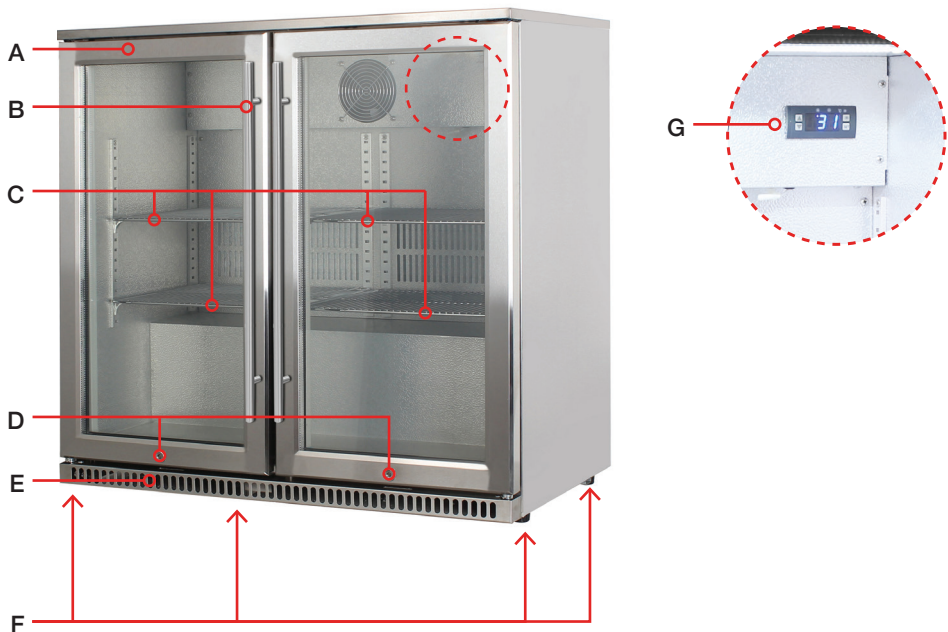

Key:	A. Stainless steel door frame
	B. Handle
	C. Shelves (x4)
	D. Door lock (x2) (front of door)
	E. Base with ventilation
	F. Levelling Legs (x4)
	G. Electronic Control Panel

Also included:

- Shelf supports (x8 + 1 spare), see page 10 for more details

Note: Not pictured

- Keys for door lock (x2), see page 16 for more details

Control Panel Layout

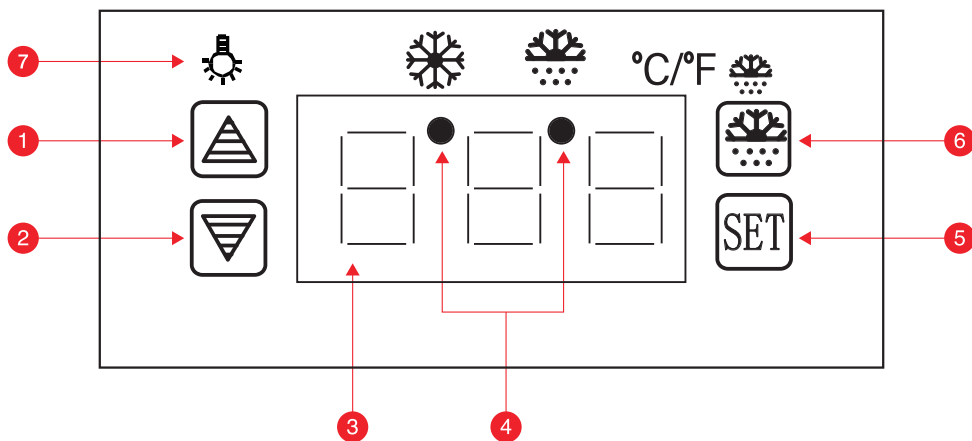

Key:

- 1 Temperature Control: Up Button**
- 2 Temperature Control: Down Button**
Press the Up or Down buttons to increase or decrease the temperature inside the Beverage Centre cabinet in 1° intervals. See more on page 12
- 3 LED Display**
- 4 Indicator Lights**
Indicator on the left relates to the Cooling Symbol: ❄️
Indicator on the right relates to the Defrost Symbol: ❄️
See pages 12–13 for more information on these
- 5 Set Temperature Button**
Press this button to set the desired temperature.
See more on page 12
- 6 Defrost Button**
Press this button to manually activate the defrost cycle.
See more on page 13
- 6 Light Function**
Press the **UP** button once to turn the light on or off.

Getting Started

Unpacking

- **Packaging materials:** This Beverage Centre has been packaged to protect it against transportation damage. Remove all packaging materials from around and inside the Beverage Centre and keep the original packaging carton and materials in a safe place. It will help prevent any damage if the product needs to be transported in the future, and you can use it to store the Beverage Centre when it is not in use. In the event the carton is to be disposed of, please recycle all packaging materials where possible.
- **Suffocation:** Plastic wrapping can be a suffocation hazard for babies and young children, so ensure all packaging materials are out of their reach and disposed of safely.
- **Power cord:** Unwind the power cord to its full length and inspect it for damage. Do not use the Beverage Centre if it or its cord have been damaged or are not working properly. In case of damage, contact our after sales support line for advice on examination, repair or return of the damaged product.
- **Read the manual:** Read this manual to familiarise yourself with the Beverage Centre. Pay particular attention to the safety instructions on the previous pages.
- **Clean:** To remove any dust from transit and storage, clean the interior and exterior surfaces of the Beverage Centre with lukewarm water and a soft cloth. Dry thoroughly.



Installation

- **Two person installation:** Use two or more able-bodied people to move and install the Beverage Centre. Failure to do so can result in back or other injury.
- **Floor surface:** This Beverage Centre must be properly positioned on a dry, sturdy, level surface that is strong enough to support it when it is fully loaded.
- **Location:** We recommend that this Beverage Centre is installed in a sheltered location with the required power safely accessible. For example: an alfresco area, under a protected verandah or in a garage. Please ensure it is not left in the weather or in direct sunlight and it is always protected from rain, water or excessive moisture.
- **Tropical Rating:** This rating allows the Beverage Centre to be operating effectively in temperatures up to 43° C.
- **Ventilation Cont.:** Ensure that the ventilation openings are never blocked or covered. Never cover shelves with aluminium foil or any other material, which may prevent air circulation.
- **Settling:** **Before connecting the Beverage Centre to the power source, let it stand upright for approximately 8 hours.** This will allow any refrigerant gasses that may have been disturbed during the transportation process to settle and reduce the possibility of a malfunction in the cooling system from handling during transport.
- **Electrical connection:** You should check whether there is an electrical socket available, which will be accessible after your appliance is installed. Plug the Beverage Centre into a dedicated, properly installed wall outlet. Do not under any circumstances cut or remove the third (earth) prong from the power cord. Any questions concerning power and/or earthing should be directed toward a licensed electrician or our after sales support centre.
- **After plugging the Beverage Centre in, turn the unit on and allow it to cool down for 3–4 hours before placing beverages in the appliance.**

Do NOT install/use the Beverage Centre in the following locations/situations:

- In a recreational vehicle, or for use with an inverter.
- In direct sunlight, near heat sources, next to an open flame, cooking or heating appliance, or near any other source of high heat.
- Direct sunlight may affect the acrylic coating and heat sources may increase the unit's power consumption. For best energy efficiency install the Beverage Centre in the coolest location within the area it is placed.
- In an area with extreme cold ambient temperatures.
- During camping.
- In an area with excessive moisture and high humidity. Make sure it is protected from elements such as wind, rain, water spray or drips.
- In an area where petrol or other explosive and/or flammable liquids or fumes are used or stored. The fumes can create a fire hazard or explosion.
- **Levelling:** It is important for the Beverage Centre to be level in order to work properly. To level the unit, adjust the levelling legs at the bottom of the Beverage Centre. See page 15 for more details on this.
- **Ventilation:** To allow for proper air ventilation, leave a minimum 5cm of space between the back, sides and top of the Beverage Centre and make sure that the front of the unit is completely unobstructed.

Positioning and Ambient Temperatures

- This Beverage Centre is rated to tropical ambient temperatures. Your Beverage Centre may not function correctly if the ambient temperature exceeds 43° C.
- Your appliance should not be located in direct sunlight or exposed to continuous heat or extremes of temperature (e.g. next to a radiator or boiler). If this is not feasible, then you should install an insulation plate between the appliance and the adjacent heat source.
- Place the Beverage Centre flatly and firmly on a solid base.
- Anything positioned above the Beverage Centre must be at least 5 cm away to allow sufficient cooling of the condenser. You must allow a 5 cm gap to the rear and either side of the appliance.
- Be sure to leave enough space for the opening of the door, to avoid damage to the appliance or personal injury.

Built-In or Freestanding Installation: Your Beverage Centre can be used as a freestanding or a built in unit. The clearances shown in the drawing below (Fig. 1) should be followed for both types of installation.

- In particular, the depth dimension must be observed.

IMPORTANT: The vent at the base of the appliance is for ventilation. Nothing should be placed in front of this vent; otherwise your Beverage Centre may not operate properly.

- A decorative plinth can be fitted to the front of the base vent as long as the cut out of 512mm wide × 40mm high is made in the plinth.

Positioning the Shelves

Position the shelf supports inside the racks on the sides (as illustrated in Fig. 2) at your required level. You can then place the shelves firmly on the supports and begin to load your contents.

Note: The maximum load for a shelf is 40kg.

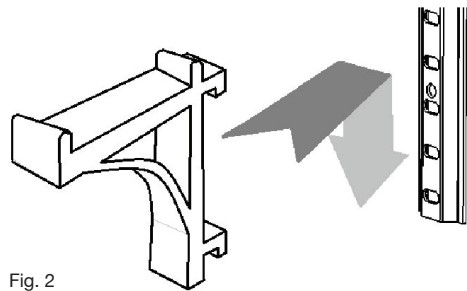

Fig. 2

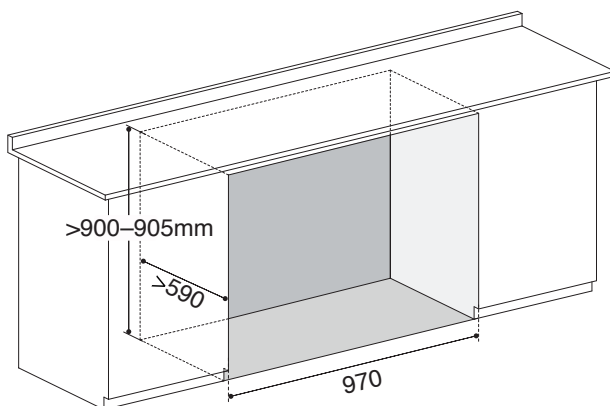

Fig. 1



Specifications

Note: Your InAlto Outdoor Beverage Centre is designed to eliminate any condensation from accumulating on the glass doors. This is achieved by heating the outer glass surface of the doors slightly. As such, it is normal for the doors to feel slightly warm when touched.

Product Dimensions (H, W, D): 850mm, 870mm, 500mm (+ 41mm handle)

Weight (Net / Gross): 51.5kg / 55kg

Temperature Range: 0–10°C

IP Rating IPX4

Other Features: Internal LED light

Electronic controls

Triple glazed doors

Single layer of heated glass (see note above)

Instructions

- **First use:** After delivery, wait for eight hours before connecting the appliance to your mains supply. This will allow any refrigerant gases that may have been disturbed during the transportation process to settle.
- **First cooling down:** When you first switch on the Beverage Centre, the compressor will run continuously until the Beverage Centre reaches the set temperature. During this period of time, try not to open the door frequently or place bottles inside the appliance. After about 3–4 hours, you can start loading the Beverage Centre.
- **Odour:** You may notice an odour when you first switch on the Beverage Centre. This is due to the parts being new and is no cause for concern. The odour will subside as the Beverage Centre starts to cool.

IMPORTANT

- When you use the Beverage Centre for the first time or restart it after it has been turned off for a long time, there could be a few degrees variance between the temperature you select and the one indicated on the LED display. This is normal and it is due to the length of activation time. Once the Beverage Centre has been running for a few hours, everything will return back to normal.
- When loading several bottles or cans at once, it will take longer for the appliance to cool the individual bottles than when adding a bottle at a time.
- If the unit is switched off or unplugged, you must allow at least 5 minutes before restarting the Beverage Centre or reconnecting it to your mains supply.

Turning the Appliance On and Off

- When the Beverage Centre is connected to the power outlet it will turn on automatically.

Normal Operation

- During normal operation the controller display will show the desired temperature that the Beverage Centre is currently set to.
- The small indicator light on the left (under the ❄️ symbol) will illuminate to confirm the Beverage Centre is in its normal cooling mode, and compressor is running.

To Set the Desired Temperature

- Press the “SET” (⊞) button once. A ‘beep’ will sound, and the display will start to flash.
- Use the “Up” or “Down” (▲ or ▼) buttons to set to the desired temperature. Fig. 3
- Press “SET” again to complete the operation. Alternatively, do not press anything for 5–10 seconds and the new desired temperature setting will be saved.

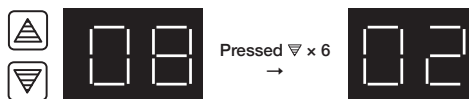

Fig. 3

Automatic Defrost

Note: The Beverage Centre is built to automatically defrost and prevent any ice forming on the evaporator.

The ‘Defrost cycle will automatically run for 20 minutes once every 8 hours.





- When in a ‘Defrost’ cycle, the indicator light will illuminate under the ❄️ symbol.

Manual Defrost

- Press the ‘Defrost’ (❄️) button and hold it down—a ‘beep’ will sound as soon as it is pressed.
- Hold button down for 6 seconds, until a second ‘beep’ can be heard.
- The indicator light will now illuminate under the ❄️ symbol and the Beverage Centre is now in ‘defrost’ cycle.
- ‘Defrost’ will run for 20 minutes, and then automatically revert to normal operation.



Manually Changing Back to Normal Operating Mode from the 'Defrost' Mode

- Press the 'Defrost' () and a 'beep' will sound.
- Hold the button down for 6 seconds, until a second 'beep' is heard.
- Both indicator lights under the  symbol and under the  symbol will now flash while the Beverage Centre is gearing up to switch back to normal operation.
- After 5–20 minutes, only the indicator light will illuminate under the  symbol to confirm the Beverage Centre is back in its normal cooling mode.

IMPORTANT

- The Beverage Centre will go through its normal automatic defrosting cycle and a manual defrosting operation is only required in most extreme cases. It is better to avoid if not necessary.
- While in the 'Defrost' mode, the Beverage Centre cooling power is reduced. The automatic cycles ensure the defrosting is done in the most efficient manner, and only when required. It is not recommended to leave the Beverage Centre in the manually set defrost mode for prolonged periods of time.

Loading the Beverage Centre

- Always check that you can close the door without it hitting a bottle or can, before shutting it.
- When loading several bottles or cans at once, it will take longer for the appliance to cool the individual bottles or cans.

IMPORTANT

- Do not overload the cabinet, and only store drinks in sealed bottles or cans.
- Storing larger or different shaped bottles may affect its storage capacity. If storing larger bottles, make sure that they do not prevent the door from shutting properly. Before shutting the door, always check that you can close it without bottles falling down inside the cabinet.

Note: The controller allows you to choose a desired operating temperature of between 0°C and 10°C. InAlto do not recommend to operate the Beverage Centre on settings of below 4°C for prolonged periods, as doing so could cause contents of the chiller to freeze. This could result in unnecessary strain on the cooling systems, and undue high energy consumption.

Operating the Internal Light

The light inside the Beverage Centre can be turned On and Off pressing the **UP** temperature button on the Temperature Control panel.



FAQs & Troubleshooting

Problem	Possible Cause	Possible Solution
The Beverage Centre does not operate	<ul style="list-style-type: none"> • The appliance is not plugged in. • The appliance is turned off. • The circuit breaker tripped or a blown fuse. 	<ul style="list-style-type: none"> • Plug in appliance. • Turn on power point. • Reset circuit breaker/replace fuse.
The Beverage Centre is not cold enough	<ul style="list-style-type: none"> • Check the temperature control setting. • The door is opened too often, or is kept open for too long. • The Beverage Centre has recently been disconnected for a period of time. The door is not closed completely. 	<ul style="list-style-type: none"> • Reduce the temperature. • Do not open door for 4 hours. • Check that the door is closed properly and for any obstructions preventing the door closing properly.
The Beverage Centre turns on and off frequently	<ul style="list-style-type: none"> • The room temperature is hotter than normal. • A large amount of contents has been added to the Beverage Centre. • The door is opened too often. • The door is not closed completely. • The temperature control is not set correctly. • The door gasket does not seal properly. 	<ul style="list-style-type: none"> • Increase air flow into room. • Do not open door for 4 hours to allow Beverage Centre to cool to temperature. • Check that the door is closed properly and for any obstructions preventing the door closing properly. • Check temperature setting and decrease if required. • Replace gasket.
Vibrations	<ul style="list-style-type: none"> • Beverage Centre is not level. • Beverage Centre is touching the wall. • If continued vibration occurs. 	<ul style="list-style-type: none"> • Level Beverage Centre. • Ensure a 5cm gap from sides and top • Turn off the Beverage Centre, unplug the power plug and contact our after sales support centre for further assistance.
The door will not close properly	<ul style="list-style-type: none"> • The Beverage Centre is not level. • The gasket is dirty. • The shelves are out of position. 	<ul style="list-style-type: none"> • Level Beverage Centre. • Clean gasket with warm water and a soft cloth. • Re-position shelves correctly.
Moisture forms on the inside walls	<ul style="list-style-type: none"> • The door is slightly open. • The door is kept open too long, or is opened too frequently. • The door does not seal properly. 	<ul style="list-style-type: none"> • Check that the door is closed properly and for any obstructions preventing the door closing properly. • Do not open door for 4 hours to allow Beverage Centre to cool to temperature. • Check if gasket is damage and replace if it is.
Moisture forms on the outside of the appliance	<ul style="list-style-type: none"> • The door is slightly open, causing cold air from inside the Beverage Centre to meet warm, moist air from outside. 	<ul style="list-style-type: none"> • Check that the door is closed properly and for any obstructions preventing the door closing properly.

Other Useful Information

Cleaning and Maintenance

WARNING

Before cleaning the appliance, make sure it is switched off and disconnected from the power supply. Failure to do so can result in electric shock or injury.

- Before cleaning: take out any drinks as well as the shelves.
- Wash the inside surfaces with a solution of lukewarm water (1L) and baking soda (2 tbsp). Use a soft, clean cloth to wipe down the surfaces, then rinse with clean water and dry with a dry cloth. Do not use soap or detergent for cleaning the cabinet. DO NOT allow the control panel, cables or plug to get wet.

NOTE: Wring excess water out of the cloth when cleaning around the controls or electrical parts.

- Make sure to keep the door gasket (seal) clean to keep the unit running efficiently.
- Wash the shelves and the outside of the cabinet with a mild detergent solution. Wipe dry with a clean soft cloth.
- Dust or anything else blocking the vent may hinder the cooling efficiency of the appliance. Always keep the vent clean; vacuum it if necessary.

WARNING

Never clean the unit with an abrasive, acid, oil or solvent based cleaning agent. Never use flammable fluids or sprays for cleaning as the fumes from these substances can create a fire hazard or explosion.

When You Are on Holidays

- Leave the Beverage Centre operating during holidays of less than three weeks. If you are not going to use the Beverage Centre for longer periods, remove all items and unplug the power cord. Clean and dry the interior thoroughly. To prevent odours and mould growth, leave the door open slightly, blocking it open if necessary.
- To move the Beverage Centre, take all items out of the appliance, securely tape down the shelves or remove them and tape the door shut. Turn the levelling leg up to the base to avoid damage.

- Protect the outside of the Beverage Centre with a blanket or similar soft material and make sure the Beverage Centre stays secure in the upright position during transportation.

Adjusting the Height and Leveling

- The appliance is equipped with adjustable feet, so that the height may be adjusted to level the cabinet on uneven floor surfaces.
- We recommend that two people carry out this procedure.
- The height must be adjusted prior to building the appliance into the housing unit and it should be set at such a height that the top panel of the appliance fits 5cm below the kitchen worktop.
- Tilt the appliance approximately 60° to allow access to the adjustable feet.
- Take care to ensure the cabinet is supported at all times.
- Twist the foot into a suitable position to level the cabinet. (Fig. 5)
- Repeat these steps for the other adjustable feet.

IMPORTANT: If the appliance is not level, then the door and door seal may be affected.

IMPORTANT: Do not move the appliance when the feet are adjusted high.

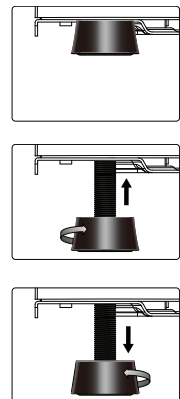

Fig. 5

Power Failure

Most power failures are corrected within a few hours and should not affect the temperature of your Beverage Centre if you minimise the number of times the door is opened. If the power is going to be off for a longer period of time, take proper steps to protect the contents.

Service and Repair

Do not attempt to alter or modify this Beverage Centre in any way. Do not attempt to repair or replace any part of the Beverage Centre unless it is specifically recommended in this manual. All other servicing should be referred to a qualified technician. Contact the after sales support line for advice.

Spare Parts

Our after sales support centre stocks a selection of spare parts for the IBF190 – 190L Outdoor Beverage Centre. To purchase a part outside of warranty, call the centre on 1300 11 4357 or email us at: support@residentiagroup.com.au

Replacing Lamps

Your Outdoor Beverage Centre uses a long-life, energy-saving LED light tube. Should you need to replace this light, please call the centre on 1300 11 4357 for a suitable replacement part.

To change the light tube:

- 1 Unplug the power plug and ensure the light switch is off.
- 2 Remove the screws on both end of the light cover.
- 3 Take off the lamp cover, pull out the wires slightly.
- 4 Gently pull out the connector at the end of the light tube.
- 5 Insert the connector into the new lamp, place the lamp cover and fasten it.

Using the Door Lock

The Outdoor Beverage Centre is equipped with door locks (Fig. 6, A) and a key (+ 1 spare) to keep your drinks safe. Please place the keys in a safe location.

To operate the lock:

- 1 Insert the key to the lock when the door is closed.
- 2 Turn the key to lock/unlock the door.



Fig. 6



Specification and Technical Parameters

This product complies with AS/NZS 60335.1 and AS/NZS 60335.2.24 electrical safety, and with EN 55014-1:2006+A1:2009 A2:2011 for electromagnetic compatibility.

Rating Label

See below. This will also be affixed to the unit.

Responsible Disposal

- At the end of its working life, do not throw this appliance out with your household rubbish. Electrical and electronic products contain substances that can have a detrimental effect on the environment and human health if disposed of inappropriately.
- This refrigeration appliance contains flammable refrigerants and insulation blowing gases, which must be removed before disposal. Observe any local regulations regarding the disposal of electrical consumer goods and dispose of it appropriately for recycling and recovery of the refrigerant. Contact your local authorities for advice on recycling facilities in your area.
- **Danger:** Risk of child entrapment! To avoid the possibility of child entrapment, take off the door and leave the shelves in place before discarding your Beverage Centre so that children cannot easily climb inside.

INALTO

Outdoor Beverage Centre 190 Litres

MODEL	IBF190
CLIMATE CLASS	T
STORAGE VOLUME	190L
PROTECTION CLASS	I
VOLTAGE	220-240V/50Hz
INPUT CURRENT	1.5A
LAMPS POWER	3.5W
IP RATE:	IPX4
REFRIGERANT	R600a/68g
DIMENSIONS (HxWxD)	850x870x541mm
FOAMING AGENT	Cyclopentane
SERIAL NO	

Made in PRC

Caution: risk of fire

E2447

Residentia Group Pty Ltd
T. 1300 11 4357
E: support@residentiagroup.com.au

Warranty Information

WARRANTY TERMS & CONDITIONS REFRIGERATION

This document sets out the terms and conditions of the product warranties for Residentia Group Appliances. It is an important document. Please keep it with your proof of purchase documents in a safe place for future reference should you require service for your Appliance.

1. IN THIS WARRANTY

- (a) 'acceptable quality' as referred to in clause 10 of this warranty has the same meaning referred to in the ACL;
 - (b) 'ACL' means Trade Practices Amendment (Australian Consumer Law) Act (No.2) 2010;
 - (c) 'Appliance' means any Residentia Group product purchased by you accompanied by this document;
 - (d) 'ASR' means Residentia Group authorised service representative;
 - (e) 'Residentia Group' means Residentia Group Pty Ltd of 165 Barkly Avenue Burnley VIC, ACN 600 546 656 in respect of Appliances purchased in Australia;
 - (f) 'major failure' as referred to in clause 10 of this warranty has the same meaning referred to in the ACL and includes a situation when an Appliance cannot be repaired or it is uneconomic for Residentia Group, at its discretion, to repair an Appliance during the Warranty Period;
 - (g) 'Warranty Period' means:
 - (i) where the Appliance is used for personal, domestic or household use (i.e. normal single family use) as set out in the instruction manual, the Appliance is warranted against manufacturing defects for 36 months, following the date of original purchase of the Appliance;
 - (h) 'you' means the purchaser of the Appliance not having purchased the Appliance for re-sale, and 'your' has a corresponding meaning.
2. This warranty only applies to Appliances purchased and used in Australia and is in addition to (and does not exclude, restrict, or modify in any way) any non-excludable statutory warranties in Australia.
 3. During the Warranty Period Residentia Group or its ASR will, at no extra charge if your Appliance is readily accessible for service, without special equipment and subject to these terms and conditions, repair or replace any parts which it considers to be defective. Residentia Group or its ASR may use remanufactured parts to repair your Appliance. You agree that any replaced Appliances or parts become the property of Residentia Group. This warranty does not apply to light globes, batteries, filters or similar perishable parts.
 4. Parts and Appliances not supplied by Residentia Group are not covered by this warranty.
 5. You will bear the cost of transportation, travel and delivery of the Appliance to and from Residentia Group or its ASR. If you reside outside of the service area, you will bear the cost of:
 - (a) travel of an authorised representative;
 - (b) transportation and delivery of the Appliance to and from Residentia Group or its ASR, in all instances, unless the Appliance is transported by Residentia Group or its ASR, the Appliance is transported at the owner's cost and risk while in transit to and from Residentia Group or its ASR.
 6. Proof of purchase is required before you can make a claim under this warranty.
 7. You may not make a claim under this warranty unless the defect claimed is due to faulty or defective parts or workmanship. Residentia Group is not liable in the following situations (which are not exhaustive):
 - (a) the Appliance is damaged by:
 - (i) accident
 - (ii) misuse or abuse, including failure to properly maintain or service
 - (iii) normal wear and tear
 - (iv) power surges, electrical storm damage or incorrect power supply
 - (v) incomplete or improper installation



- (vi) incorrect, improper or inappropriate operation
 - (vii) insect or vermin infestation
 - (viii) failure to comply with any additional instructions supplied with the Appliance;
- (b) the Appliance is modified without authority from Residentia Group in writing;
- (c) the Appliance's serial number or warranty seal has been removed or defaced;
- (d) the Appliance was serviced or repaired by anyone other than Residentia Group, an authorised repairer or ASR.
8. This warranty, the contract to which it relates and the relationship between you and Residentia Group are governed by the law applicable where the Appliance was purchased.
9. To the extent permitted by law, Residentia Group excludes all warranties and liabilities (other than as contained in this document) including liability for any loss or damage whether direct or indirect arising from your purchase, use or non use of the Appliance.
10. For Appliances and services provided by Residentia Group in Australia, the Appliances come with a guarantee by Residentia Group that cannot be excluded under the Australian Consumer Law. You are entitled to a replacement or refund for a major failure and for compensation for any other reasonably foreseeable loss or damage. You are also entitled to have the Appliance repaired or replaced if the Appliance fails to be of acceptable quality and the failure does not amount to a major failure. The benefits to you given by this warranty are in addition to your other rights and remedies under a law in relation to the Appliances or services to which the warranty relates.
11. At all times during the Warranty Period, Residentia Group shall, at its discretion, determine whether repair, replacement or refund will apply if an Appliance has a valid warranty claim applicable to it.
12. Missing parts are not covered by warranty. Residentia Group reserves the right to assess each request for missing parts in a case by case basis. Any parts that are not reported missing in the first week after purchase will not provide free of charge.
13. To enquire about claiming under this warranty, please follow these steps:
- (a) carefully check the operating instructions, user manual and the terms of this warranty;
 - (b) have the model and serial number of the Appliance available;
 - (c) have the proof of purchase (e.g. an invoice) available;
 - (d) telephone the numbers shown below.
14. You accept that if you make a warranty claim, Residentia Group and its ASR may exchange information in relation to you to enable Residentia Group to meet its obligations under this warranty.

IMPORTANT

Before calling for service, please ensure that the steps in point 13 have been followed.

Telephone contact

- ▶ Service: Please call 1300 11 HELP (4357)
- ▶ Spare Parts: Please call 1300 11 SPARE (7727)

The Australian Consumer Law requires the inclusion of the following statement with this warranty:

Our goods come with guarantees that cannot be excluded under the Australian Consumer Law. You are entitled to a replacement or refund for a major failure and for compensation for any other reasonably foreseeable loss or damage. You are also entitled to have the goods repaired or replaced if the goods fail to be of acceptable quality and the failure does not amount to a major failure.

A HIGHER LEVEL

INALTO?

OF LIVING

WWW.INALTO.HOUSE



E2447