

USER MANUAL

INALTO?

INALTO.HOUSE

90cm Built-in 9 Function Oven

MODEL CODE

IO9060XL9T



FOR ALL AUSTRALIAN HOMES

V3.0 | 1021

Welcome!

Residentia Group Pty Ltd

—

Head Office

165 Barkly Avenue, Burnley
Victoria Australia 3066

—

Postage

PO Box 5177, Burnley
Victoria Australia 3121

—

ACN.

600 546 656

—

Online

residentia.group
www.inalto.house

 / inalto.house

 / inalto.house

Congratulations on purchasing your new appliance.
The InAlto brand is proudly distributed within Australia
by Residentia Group Pty Ltd.

Please refer to the warranty card at the rear of this manual for
information regarding your product's parts and labour warranty,
or visit us online at www.residentia.group

At Residentia Group, we are customer obsessed and our
Support Team are there to ensure you get the most out of your
appliance. Should you want to learn more about the various
features of your appliance, and importantly taking care of it
when cleaning, our Support Team are here to help. You can
use our online Support Centre at anytime by visiting:
<http://support.residentiagroup.com.au>

You can contact us via calling us on 1300 11 HELP (4357)
Or email us at: support@residentiagroup.com.au

It is important that you read through the following use and care
manual thoroughly to familiarise yourself with the installation
and operation requirements of your appliance to ensure
optimum performance. Please note, this manual has been
prepared for multiple models. Your appliance may not feature
some functions specified in the manual. Products marked with
(*) are optional.

Again, thank you for choosing an InAlto appliance and we look
forward to being of service to you.

Kind Regards,
The Residentia Team



**A RESIDENTIA
GROUP INITIATIVE**

Contents

Page

Important warnings	4
Electrical connection	12
Introducing the appliance	13
Accessories	14
Technical specifications	15
Installation of appliance	15
Control panel	21
Using the oven	23
Using the grill	28
Using the chicken rotisserie	28
Program types	29
Cooking recommendations	30
Cooking table	31
Maintenance and cleaning	32
Steam cleaning	32
Cleaning and mounting oven door	33
Cleaning oven glass	34
Catalytic panel	34
Rack positions	35
Replacing oven lamp	35
Troubleshooting	36
Handling rules	38
Recommendations for energy saving	38
Environmentally-friendly disposal	39
Package information	39
Warranty information	40

IMPORTANT WARNINGS

1. Installation and repair should always be performed by **“AUTHORIZED SERVICE”**. Manufacturer shall not be held responsible for operations performed by unauthorized persons.

2. Please read this operating instructions carefully. Only by this way you can use the appliance safely and in a correct manner.

3. The oven should be used according to operating instructions.

4. Keep children below the age of 8 and pets away when operating.

5. **The accessible parts may be hot during use. Young children must be kept away.**

6. **WARNING: Danger of fire: do not store items on the cooking surfaces.**

7. **WARNING: During use the appliance becomes hot. Care should be taken to avoid touching heating elements inside the oven.**

8. Setting conditions of this device are specified on the label. (Or on the data plate)

9. The accessible parts may be hot when the grill is used. Small children should be kept away.

10. **WARNING: This appliance is intended for cooking. It should not be used for other purposes like heating a room.**

11. To clean the appliance, do not use steam cleaners.

12. Ensure that the oven door is completely closed after putting food inside the oven.

13. NEVER try to put out the fire with water. Only shut down the device circuit and then cover the flame with a cover or a fire blanket.

14. WARNING: Children less than 8 years of age shall be kept away unless continuously supervised.

15. Touching the heating elements should be avoided.

16. CAUTION: Cooking process shall be supervised. Cooking process shall always be supervised.

17. This appliance can be used by children aged from 8 years and above and persons with reduced physical, sensory or mental capabilities or lack of experience and knowledge if they have been given supervision or instruction concerning use of the appliance in a safe way and understand the hazards involved. Children shall not play with the appliance. Cleaning and user maintenance shall not be made by children without supervision.

18. This device has been designed for household use only.

19. Children must not play with the appliance. Cleaning or user maintenance of the appliance shall not be performed by children unless they are older than 8 years and supervised by adults.

20. Keep the appliance and its power cord away from children less than 8 years old.

21. Put curtains, tulle, paper or any flammable (ignitable) material away from the appliance before starting to use the appliance. Do not put ignitable or flammable materials on or in the appliance.

22. Keep the ventilation channels open.

23. The appliance is not suitable for use with an external timer or a separate remote control system.

24. Do not heat closed cans and glass jars. The pressure may lead jars to explode.

25. Oven handle is not a towel drier. Do not hang towels, etc. on the oven handle.

26. Do not place the oven trays, plates or aluminium foils directly on the oven base. The accumulated heat may damage the base of the oven.

27. While placing food to or removing food from the oven, etc., always use heat resistant oven gloves.

28. Do not use the product in states like medicated and/or under influence of alcohol which may affect your ability of judgement.

29. Be careful when using alcohol in your foods. Alcohol will evaporate at high temperatures and may catch fire to cause a fire if it comes in contact with hot surfaces.

30. After each use, check if the unit is turned off.

31. If the appliance is faulty or has a visible damage, do not operate the appliance.

32. Do not touch the plug with wet hands. Do not pull the cord to plug off, always hold the plug.

33. Do not use the appliance with its front door glass removed or broken.

34. Place the baking paper together with the food into a pre-heated oven by putting it inside a cooker or on an oven accessory. (tray, wire grill etc.)

35. Do not put objects that children may reach on the appliance.

36. It is important to place the wire grill and tray properly on the wire racks and/or correctly place the tray on the rack. Place the grill or tray between two rails and make sure it is balanced before putting food on it.

37. Against the risk of touching the oven heater elements, remove excess parts of the baking paper that hang over from the accessory or container.

38. Never use it at higher oven temperatures than the maximum usage temperature indicated on your baking paper. Do not place the baking paper on the base of the oven. Against the risk of touching the oven heater elements, remove excess parts of the baking paper that hang over from the accessory or container.

39. When the door is open, do not place any heavy object on the door or allow children to sit on it. You may cause the oven to overturn or the door hinges to be damaged.

40. The packaging materials are dangerous for children. Keep packaging materials away from the reach of children.

41. Do not use abrasive cleaners or sharp metal scrapers to clean the glass as the scratches that may occur on the surface of the door glass may cause the glass to break.

42. User should not handle the oven by himself.

43. During usage, the internal and external surfaces of the oven get hot. As you open the oven door, step back to avoid the hot vapour coming out from the interior. There is risk of burning.

44. Do not place heavy objects when oven door is open, risk of toppling.

45. Oven supply can be disconnected during any construction work at home. After completing the work, re-connecting the oven shall be done by authorized service.

46. User should not dislocate the resistance during cleaning. It may cause an electric shock.

47. To prevent overheating, the appliance should not be installed behind of a decorative cover.

48. Turn off the appliance before removing the safeguards. After cleaning, install the safeguards according to instructions.

49. Cable fixing point shall be protected.

50. Please don't cook the food directly on the tray / grid. Please put the food into or on appropriate tools before putting them in the oven.

Electrical Safety

1. Plug the appliance in a grounded socket protected by a fuse conforming to the values specified in the technical specifications chart.
2. Have an authorized electrician set grounding equipment. Our company shall not be responsible for the damages that shall be incurred due to using the product without grounding according to local regulations.
3. The circuit breaker switches of the oven shall be placed so that end user can reach them when the oven is installed.
4. The power supply cord (the cord with plug) shall not contact the hot parts of the appliance.
5. If the power supply cord (the cord with plug) is damaged, this cord shall be replaced by the manufacturer or its service agent or an equally qualified personnel to prevent a hazardous situation.
6. Never wash the appliance by spraying or pouring water on it. There is a risk of electrocution.
7. **WARNING: To avoid electric shock, ensure that the device circuit is open before changing the lamp.**
8. **WARNING: Cut off all supply circuit connections before accessing the terminals.**
9. Do not use cut or damaged cords or extension cords other than the original cord.
10. Make sure that there is no liquid or humidity in the outlet where the product plug is installed.

11. The rear surface of the oven also heats up when the oven is operated. Electrical connections shall not touch the rear surface, otherwise the connections may be damaged.

12. Do not tighten the connecting cables to the oven door and do not run them over hot surfaces. If the cord melts, this may cause the oven to short circuit and even a fire.

13. Unplug the unit during installation, maintenance, cleaning and repair.

14. If the power supply cable is damaged, it must be replaced by its manufacturer or authorized technical service or any other personnel qualified at the same level, in order to avoid any dangerous situation.

15. Make sure the plug is inserted firmly into wall socket to avoid sparks.

16. Do not use steam cleaners for cleaning the appliance, otherwise electric shock may occur.

17. An omnipolar switch capable to disconnect power supply is required for installation. Disconnection from power supply shall be provided with a switch or an integrated fuse installed on fixed power supply according to building code.

18. Appliance is equipped with a **type "Y"** cord cable.

19. Fixed connections shall be connected to a power supply enabling omnipolar disconnection. For appliances with over voltage category below III, disconnection device shall be connected to fixed power supply according to wiring code.

Intended Use

- 1.** This product has been designed for domestic use. Commercial use is not permitted.
- 2.** This appliance may only be used for cooking purposes. It shall not be used for other purposes like heating a room.
- 3.** This appliance shall not be used to heat plates under the grill, drying clothes or towels by hanging them on the handle or for heating purposes.
- 4.** The manufacturer assumes no responsibility for any damage due to misuse or mishandling.
- 5.** Oven part of the unit may be used for thawing, roasting, frying and grilling food.
- 6.** Operational life of the product you have purchased is 10 years. This is the period for which the spare parts required for the operation of this product as defined is provided by the manufacturer.

Electrical Connection

This oven must be installed and connected to its place correctly according to manufacturer instructions and by an authorized service.

Appliance must be installed in an oven enclosure providing high ventilation.

Electrical connections of the appliance must be made only via sockets having earth system furnished in compliance with rules. Contact an authorized electrician if there is no socket complying with the earthed system at where appliance will be placed. Manufacturing company is by no means responsible for damage resulting from connection of non-earthed sockets to appliance.

Plug of your oven must be earthed; ensure that socket for the plug is earthed. Plug must be located in a place that can be accessed after installation.

Your oven has been manufactured as 220-240 V 50/60 Hz. AC power supply compliant and requires a 16 Amp fuse. If your power network is different than these indicated values, refer to an electrician or your authorized service.

When you need to replace the electrical fuse, please ensure that electrical connection is made as follows:

- Phase (to live terminal) brown cable
- Blue cable to neutral terminal
- Yellow-green cable to earth terminal

Oven disconnecting switches must be in an accessible place for final user while oven is in its place.

Power supply cable (plug in cable) mustn't touch hot parts of the appliance.

If supply cord (plug in cable) is damaged, this cord must be replaced by the importer or its service agent or an equally competent personnel to prevent a hazardous situation.

INTRODUCING THE APPLIANCE

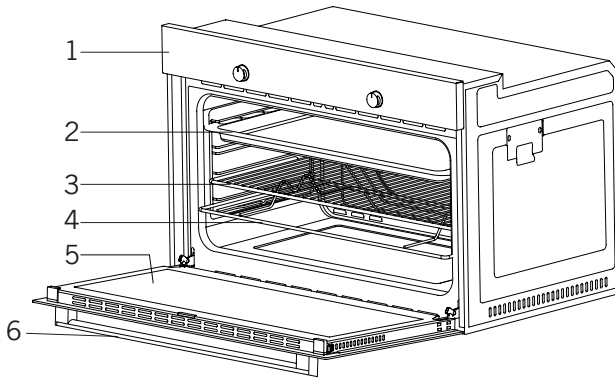

- 1. Control panel
- 2. Deep tray
- 3. In tray wire grill

- 4. Roast chicken skewer *
- 5. Oven door
- 6. Handle

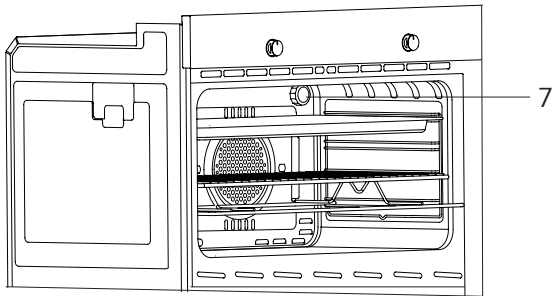

- 7. Lamp

Accessories (optional)



Deep tray *

Used for pastry, big roasts, watery foods. It can also be used as oil collecting container if you roast directly on grill with cake, frozen foods and meat dishes.

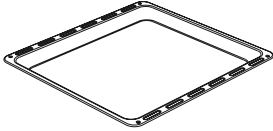

Tray

Used for pastry (cookie, biscuit etc.), frozen foods.

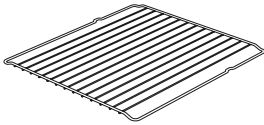

Wire grill

Used for roasting or placing foods to be baked, roasted and frozen into desired rack.

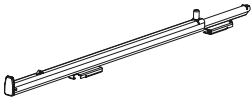

Telescopic rail *

Trays and wire racks can be removed and installed easily thanks to telescopic rails.



In tray wire grill *

Foods to stick while cooking such as steak are placed on in tray grill. Thus contact of food with tray and sticking are prevented.

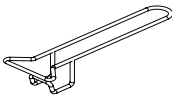

Tray handle *

It is used to hold hot trays.

Technical Specifications

Specifications	90 cm Built-in Oven
Lamp power	15-25 W
Thermostat	40-240 / Max °C
Lower heater	2000 W
Upper heater	1500 W
Turbo heater	1 x 2200 W / 2 x 1250 W
Grill heater	3250 W
Supply voltage	220-240V AC 50/60 Hz

Technical specifications can be changed without prior notice to improve product quality.

The values provided with the appliance or its accompanying documents are laboratory readings in accordance with the respective standards. These values may differ depending on the use and ambient conditions.

Figures in this guide are schematic and may not be exactly match your product.

INSTALLATION OF APPLIANCE

Ensure that electrical installation is suitable for operationalising the appliance. If not, call an electrician and plumber to make necessary arrangements. Manufacturing firm can't be hold responsible for damages to arise due to operations by unauthorized people and product warranty becomes void.

WARNING: It is customer's responsibility to prepare the location the product shall be placed on and also have power utility prepared.

WARNING: The rules about electrical local standards must be adhered to during product installation.

WARNING: Check for any damage on the product before installing it. Do not have product installed if it's damaged. Damaged products pose danger for your safety.

Important Warnings for Installation:

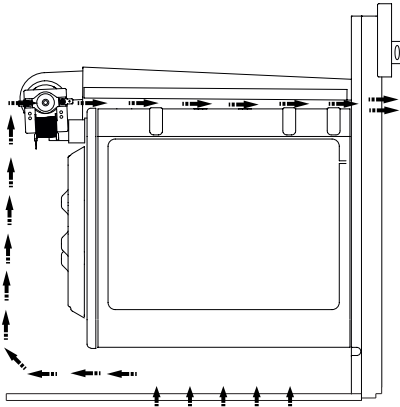

Figure 1

Cooling fan shall take extra steam out and prevent outer surfaces of appliance from overheating during operation of oven. This is a necessary condition for better appliance operation and better cooking. Cooling fan shall continue operation after cooking is finished. Fan shall automatically stop after cooling is completed. A clearance must be left behind the enclosure where you'll place the appliance for efficient and good operation.

This clearance shouldn't be ignored as it's required for ventilation system of the appliance to operate.

Right Place For Installation

Product has been designed to be mounted to worktops procured from market. A safe distance must be left between the product and kitchen walls or furniture. See the drawing provided on the next page for proper distances. (values in mm).

- Used surfaces, synthetic laminates and adhesives must be heat resistant. (minimum 100°C)
- Kitchen cupboards must be level with product and secured.
- If there is a drawer below the oven, a rack must be placed between oven and drawer.

WARNING: Do not install the product next to refrigerators or coolers. The heat emitted by the product increases the energy consumption of cooling devices.

WARNING: Do not use door and/or handle to carry or move the product.

90 cm Built-In Oven Installation and Mounting

Place of use for product must be located before starting installation.

Product mustn't be installed in places which are under the effect of strong air flow.

Carry the product with minimum two people. Do not drag the product so that floor isn't damaged.

Remove all transportation materials inside and outside the product. Remove all materials and documents in the product.

Installation Under Counter

Cabin must match the dimensions provided in figure 2.

A clearance must be provided at the rear part of the cabin as indicated in the figure so that necessary ventilation can be achieved.

After mounting, the clearance between lower and upper part of the counter is indicated in figure 5 with "A". It's for ventilation and shouldn't be covered.

Installation In An Elevated Cabinet

Cabin must match the dimensions provided in figure 4.

The clearances with the dimensions indicated in the figure must be provided at the rear part of cabin, upper and lower sections so that necessary ventilation can be achieved.

Installation Requirements

Product dimensions are provided in the figure 3.

Furniture surfaces for mounting and mounting materials to be used must have a minimum temperature resistance of 100 °C.

Mounting cabin must be secured and its floor must be plane for product not to tilt over.

Cabin floor must have a minimum strength that would handle a load of 60 kg.

Placing and Securing the Oven

Place the oven into the cabin with two or more people.

Ensure that oven's frame and front edge of the furniture match uniformly.

Supply cord mustn't be under the oven, squeeze in between oven and furniture or bend.

Fix the oven to the furniture by using the screws provided with the product. Screws must be mounted as shown in figure 5 by passing them through plastics attached to frame of the product. Screws mustn't be overtightened. Otherwise, screw sockets might be worn.

Check that oven doesn't move after mounting. If oven isn't mounted in accordance with instructions, there is a risk of tilt over during operation.

Electrical Connection

Mounting place of the product must have appropriate electrical installation.

Network voltage must be compatible with the values provided on type label of product.

Product connection must be made in accordance with local and national electrical requirements.

Before starting the mounting disconnect network power. Do not connect the product to network until its mounting is completed.

Mounting



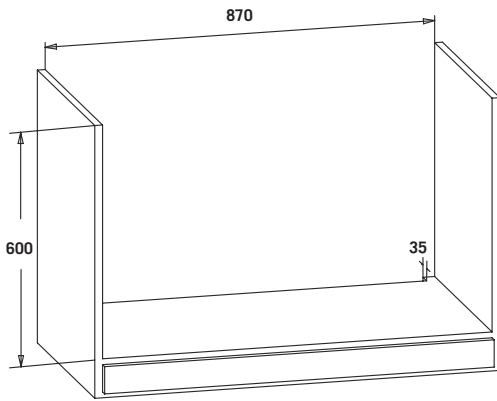

Figure 2

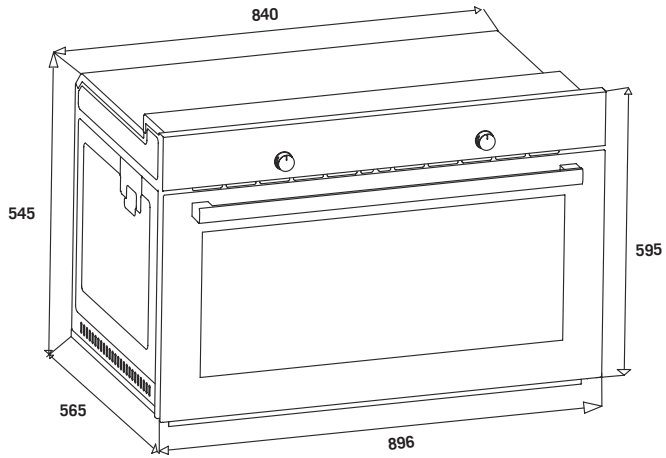
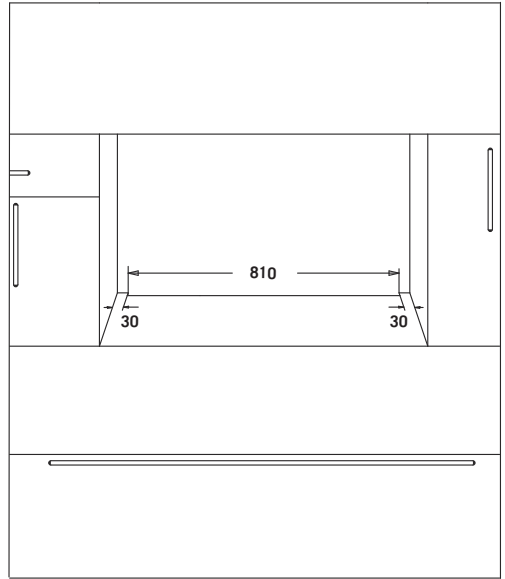

Figure 3

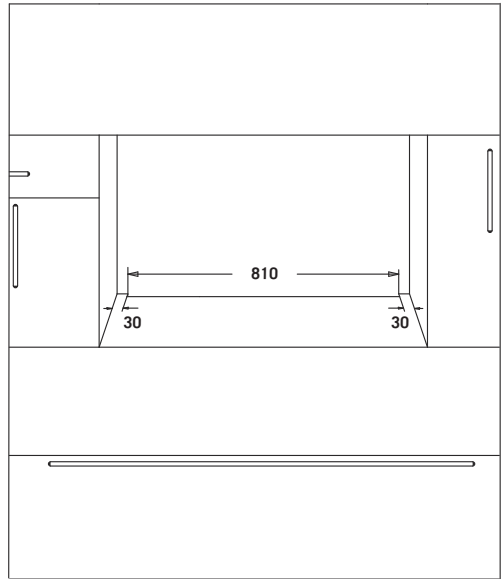
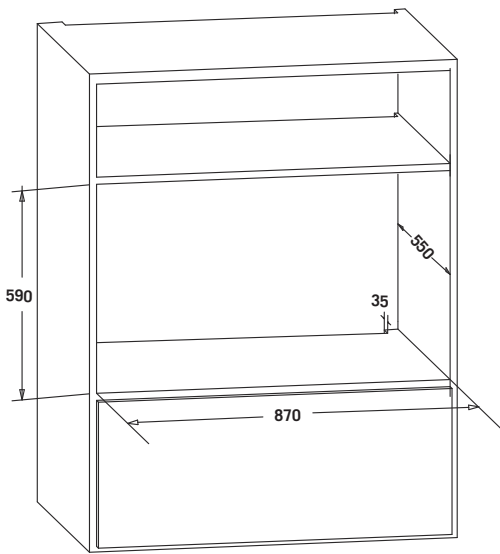
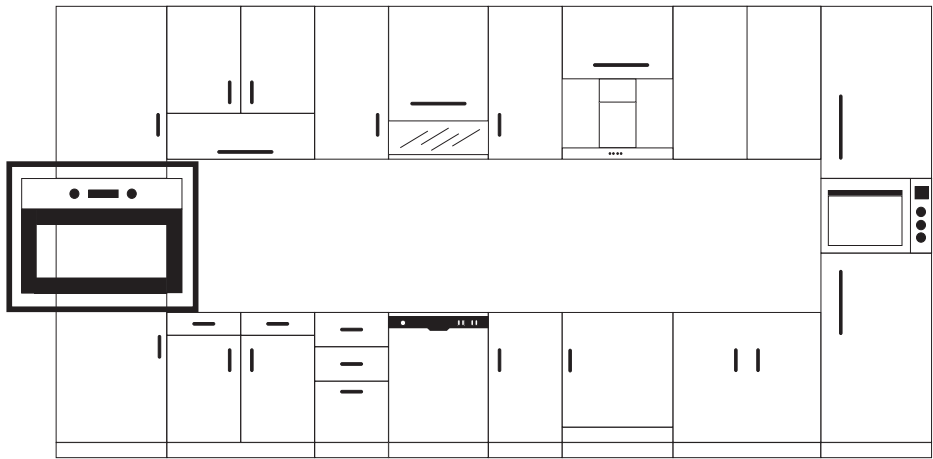

Figure 4

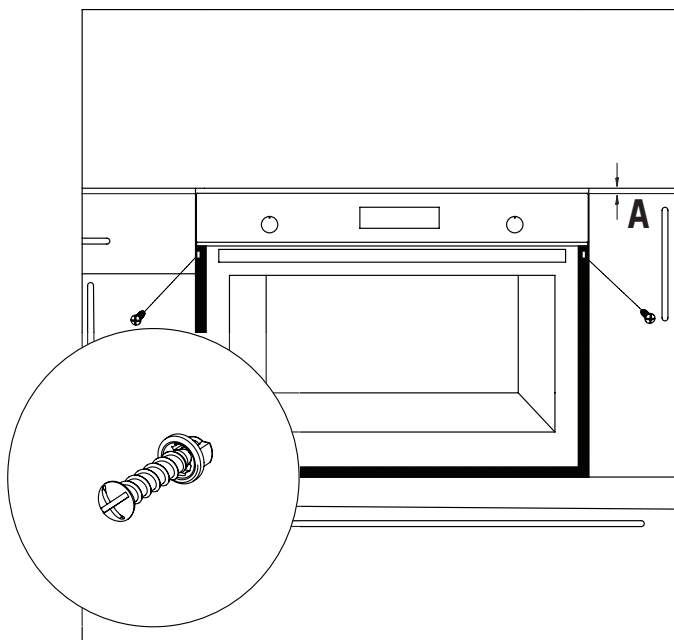
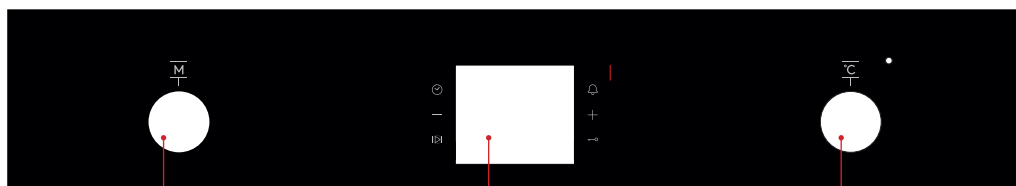

Figure 5

CONTROL PANEL



1

2

3

1. Function button
2. Mechanical or digital timer
3. Thermostat

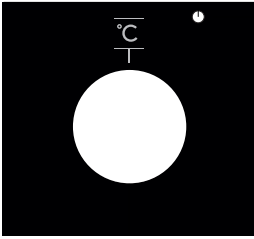

Thermostat Button: Helps to set cooking temperature of the food to be cooked in the oven. You can set the desired temperature by turning the button after placing the food into the oven. Check cooking table related to cooking temperatures of different foods.

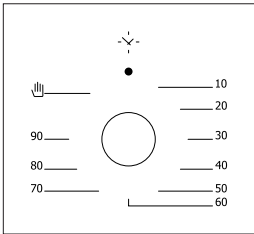

Mechanical Timer Button *: Helps to set time for the food to be cooked in the oven. Timer de-energizes the heaters when set time expires and warns you by ringing. See cooking table for cooking times.

Using Pop-up Button *

Adjustment can be made only when button is popped for models with pop-up button.

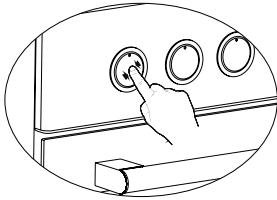

Make sure that button is popped by pressing on the button as shown in the figure at left side.

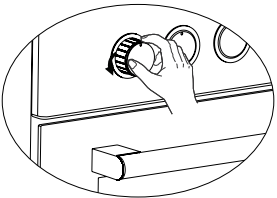

You can make necessary adjustments by turning right or left when button is popped enough.

USING THE OVEN

Initial Use Of Oven

Here are the things you must do at first use of your oven after making its necessary connections as per instructions:

1. Remove labels or accessories attached inside the oven. If any, take out the protective folio on front side of the appliance.

2. Remove dust and package residues by wiping inside of the oven with a damp cloth. Inside of oven must be empty. Plug the cable of appliance into the electrical socket.

3. Set the thermostat button to the highest temperature (240 Max. °C) and run the oven for 30 minutes with its door closed. Meanwhile a slight smoke and smell might occur and that's a normal situation.

4. Wipe inside of the oven with a slightly warm water with detergent after it becomes cold and then dry with a clean cloth. Now you can use your oven.

Normal Use Of Oven

1. Adjust thermostat button and temperature at which you want to cook the food to start cooking.

2. You can set cooking time to any desired time by using the button at models with mechanical timer. Timer will de-energize heaters when time expired and provide warning beep as ringing.

3. Timer turns the heaters off and provides audible signal when cooking time expires in line with the information entered in the models with digital timer.

4. Cooling system of the appliance will continue to operate after cooking is completed. Do not cut the power of appliance in this situation which is required for appliance to cool down. System will shut down after cooling is completed.

Time of day
adjustment button

Minus
button

Automatic
cooking button









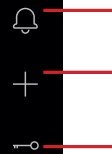





Minute minder
button

Plus
button

Child lock
button







SCREEN SYMBOLS

	<p>Automatic cooking status indication</p> <ul style="list-style-type: none"> • On: Full or semi auto-cooking active. • Flashing: Auto cooking completed or power on condition. • Off: No auto cooking active.
	<p>Oven status indication</p> <ul style="list-style-type: none"> • On: Timer relay is closed / cooking or ready for cooking. • Off: Timer relay is open / no cooking.
	<p>Manual cooking status indication</p> <ul style="list-style-type: none"> • On: Manual cooking. • Off: Auto cooking (auto symbol is on).
	<p>Semi automatic cooking adjustment mode indication</p> <ul style="list-style-type: none"> • Flashing: Cooking duration adjustment mode, adjustment possible by  or  buttons.
	<p>Full automatic cooking adjustment mode indication</p> <ul style="list-style-type: none"> • Flashing: End of cooking time adjustment mode, adjustment possible by  or  buttons.
	<p>Minute minder status indication</p> <ul style="list-style-type: none"> • On: Minute minder alarm active • Flashing: Minute minder adjustment mode, adjustment possible by  or  buttons or current minute minder alarm completed. • Off: Minute minder is not active.
	<p>Child lock indication</p> <ul style="list-style-type: none"> • On: Child lock is active. • Off: Child lock is inactive.





POWER ON

At power on, oven is inactive, time of day and AUTO symbols are flashing. The indicated (flashing) time of day is not correct and has to be adjusted. Press  to activate the oven and proceed adjusting the time of day as below.



TIME OF DAY ADJUSTMENT

Time of day adjustment is only possible when no cooking program is in progress. Press  to enter the adjustment mode, the double dot symbol in between hours and minutes digits will start to flash. Using either  or  adjust the desired duration. The maximum adjustable duration is 23h 59 minutes. Adjustment mode will be abandoned within 5 seconds after the last button press or can be terminated immediately by pressing the .

SETTING THE MINUTE MINDER

With this function, you can adjust a duration in minutes. After the adjusted time has been elapsed, an alarm sound will be produced. Press  to enter the minute minder adjustment mode,  symbol will start flashing on the screen. Using either  or  adjust the desired duration. The maximum adjustable duration is 23h 59 minutes. Adjustment mode will be abandoned within 5 seconds after the last button press or can be terminated immediately by pressing the  button.

CANCELLING THE MINUTE MINDER







Any active minute minder function can be cancelled by pressing and holding  button for 3 seconds. The  symbol on the screen, indicating the active minute minder function, will disappear.

CANCELLING THE ALARM BUZZER SOUND

Once the adjusted minute minder duration is elapsed, the buzzer alarm will start to sound, accompanied by the flashing  symbol on the screen. Any button press will stop the alarm sound and this indication. If no button is pressed, the alarm sound will end automatically after 7 minutes, but the flashing symbol will go on.







SEMI AUTOMATIC COOKING

This cooking program is intended to start cooking immediately for a specified duration. After the oven is set to the desired function and temperature via the oven knobs:



1. Press the  button,  symbol will flash on the screen.
2. Using  or  buttons, adjust the desired cooking duration. **AUTO** symbol appears on the screen, whereas  disappears.
3. After 5 seconds of the last button press or by pressing  twice, the adjustment is completed.  symbol disappears, the display shows the current time of day.

FULL AUTOMATIC COOKING

This cooking program is intended to perform a delayed cooking by programming the time of day, when the food should be ready. In other words, the oven will start cooking not immediately but will automatically calculate the time to start cooking.

1. Perform step 1 and 2 of the semi auto cooking as above (cooking duration adjustment).
2. Press  button once again,  symbol will start to flash.
3. Using  or , program the end of cooking time.  symbol will disappear but **AUTO** symbol will be still present on the screen. This indicates that an automatic cooking is programmed but cooking has not started yet.
4. After 5 seconds of the last button press or by pressing , the adjustment will be completed,  symbol disappears from the screen the display shows the current time of day.

MANUAL MODE

Any automatic cooking in progress, can be cancelled by pressing and holding  button for 3 seconds. **AUTO** symbol will disappear and  will appear. In manual mode, the oven will be active depending on the status of the oven knobs.

AUTO COOKING END

After the automatic cooking has been completed, **AUTO** symbol will be flashing on the screen and the buzzer alarm will sound. Any button press will stop the alarm sound but the flashing symbol will go on till  button is pressed. The buzzer alarm will sound for 7 minutes if not stopped.



POWER INTERRUPTS

After any interrupt of mains power, your oven will be inactive after the power is restored, for safety reasons. After power on, the time of day digits and **AUTO** symbol will flash and the time of day has to be adjusted (see: power on).

Note: The flashing **AUTO** symbol indicates that the oven is inactive and you have to enter the manual mode.

CHILD LOCK

This function is intended to prevent any unauthorized modification of the timer settings. When this function is active, any button press except the  button itself, will be inactive.

To activate this function, press and hold the  button until  appears on the screen, approximately for 3 seconds. To deactivate it, do the same until the  symbol disappears.

Note: Any alarm sound can be stopped by any button press, even the child lock function is active.

PROGRAMMABLE OPTIONS

Alarm tone:

Whenever no adjustment mode is active, pressing and holding the  button will result in the currently valid buzzer tone being produced. By releasing and pressing the same button again, you may scroll through 3 available buzzer tones. The last heard buzzer tone will be automatically recorded as the selected tone.

Note: Programmable options are nonvolatile and will be resident after any power failure.

Using The Grill

1. When you place the grill on the top rack, the food on the grill shall not touch the grill.
2. You can preheat for 5 minutes while grilling. If necessary, you may turn the food upside down.
3. Food shall be in the center of the grill to provide maximum air flow through the oven.

To turn on the grill;

1. Place the function button over the grill symbol.
2. Then, set it to the desired grill temperature.

To turn the grill off;

Set the function button to the off position.

WARNING: Keep the oven door closed while grilling.

Using The Chicken Roasting *

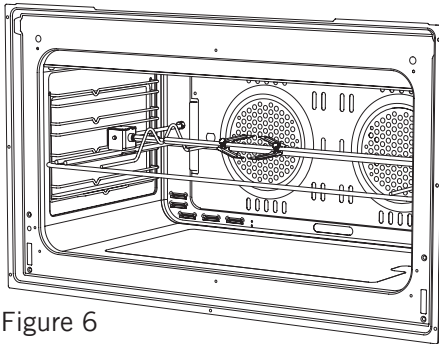
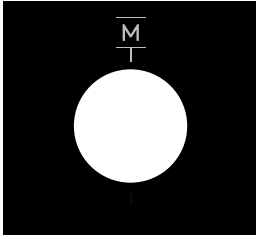

Figure 6

Place the spit on the frame. Slide turn spit frame into the oven at the desired level. Locate a dripping pan through the bottom in order to collect the fat. Add some water in dripping pan for easy cleaning. Do not forget to remove plastic part from spit. After grilling, screw the plastic handle to the skewer and take out the food from oven.

PROGRAM TYPES



Program Mode Knob: This knob pushes out to reveal the function on the knob. Use this to select which function you wish to use.

Heating program types in your appliance and important explanations of them are provided below for you can cook different foods appealing to your taste.

Fan Assist:

Circulate the air within the oven cavity.

Fan Forced:

Suitable for baking and roasting. Keep heat setting lower than the Bake (Conventional) program since heat is conveyed immediately via air flow.

Fan Bake:

The program suitable for cooking foods like cakes, dried cakes, lasagna. Suitable for cooking meat dishes, as well.

Grill & Fan:

Suitable for cooking meat type foods. Do not forget to place a cooking tray in a lower rack inside the oven and a little water in it while grilling.

Grill:

Grill cooking is used for grilling meat like foods such as steak, sausage and fish. While grilling, tray should be placed in the lower rack and water must be placed in it.

Upper Heating Element:

Used for post heating or roasting very little pieces of foods.

Steam Cleaning:

Refer to page 32 for Steam Cleaning instructions.

Bake (Conventional):

A program that can be used for cooking foods like cake, pizza, biscuit and cookie.

Light:

Enables the user to observe the progress of cooking without opening the door.

COOKING RECOMMENDATIONS

You can find in the following table the information of food types which we tested and identified their cooking values in our labs. Cooking times can vary depending on the network voltage, quality of material to be cooked, quantity and temperature. Dishes to cook by using these values might not appeal to your taste. You can set various values for obtaining different tastes and results appealing to your taste by making tests.

WARNING: Oven must be preheated for 7-10 minutes before placing the food in it.

Cooking Table

Food	Cooking function	Cooking temperature (°C)	Cooking rack	Cooking time (min.)
Cake	Static	180	2	70
Small cake	Static	180	2	40
Pie	Static	200	2	70
Pastry	Static+fan	180-200	2	20-25
Cookie	Static	175	2	20
Apple pie	Static	180-190	1	150
Sponge cake	Static	175	2	45-50
Pizza	Static	190	2	25
Lasagne	Static	180-200	2	50-60
Meringue	Static	100	2	60
Grilled chicken *	Grill+fan	220	4	25-35
Grilled fish *	Grill+fan	220	4	35-40
Calf steak *	Grill	Max.	4	30
Grilled meatball *	Grill	Max.	4	40

* Food must be turned after half of the cooking time.

MAINTENANCE AND CLEANING

1. Remove the power plug from electrical socket.
2. Do not clean inner parts, panel, trays and other parts of the product with hard tools such as bristle brush, wire wool or knife. Do not use abrasive, scratching materials or detergent.
3. Rinse after wiping the parts at inner parts of the product with soapy cloth, then dry thoroughly with a soft cloth.
4. Clean glass surfaces with special glass cleaning material.
5. Do not clean your product with steam cleaners.
6. Never use combustibles like acid, thinner and gas while cleaning your product.
7. Do not wash any part of the product in dishwasher.
8. "Use potassium stearate (soft soap) for dirt and stains.

Steam Cleaning *

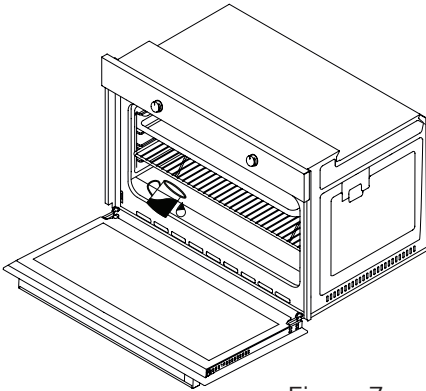

Figure 7

It enables cleaning the soils softened thanks to the steam to be generated in the oven.

1. Remove all the accessories in the oven.
2. Pour a half litre of water into the tray and Place the tray at the bottom of the boiler.
3. Set the switch to the steam cleaning mode.
4. Set the thermostat to 70 °C degrees and operate the oven for 30 minutes.
5. After operating the oven for 30 minutes, open the oven door and wipe the inner surfaces with a wet cloth.
6. Use dish-washing liquid, warm water and a soft cloth for stubborn dirt, then dry off the area you have just cleaned with a dry cloth.

Cleaning And Mounting Oven Door

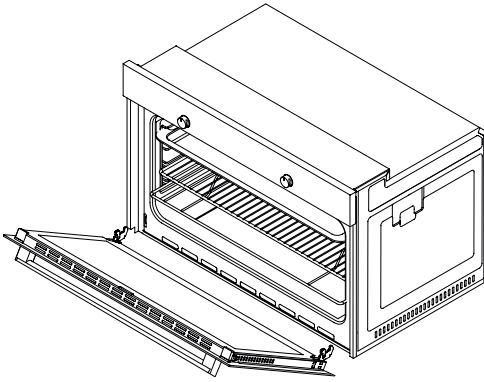

Figure 8

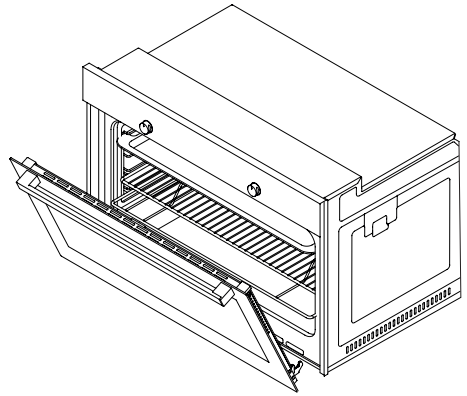

Figure 9

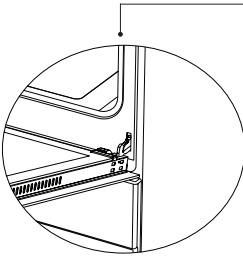

Figure 8.1

Open the door fully by pulling the oven door toward yourself. Then perform unlock operation by pulling the hinge lock upwards with the aid of screwdriver as indicated in **figure 8.1**.

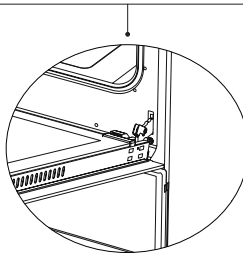

Figure 8.2

Set the hinge lock to the widest angle as in **figure 8.2**. Adjust both hinges connecting oven door to the oven to the same position.

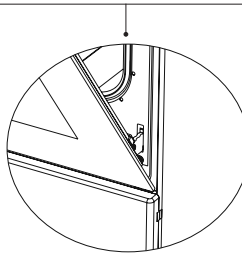

Figure 9.1

Later, close the opened oven door so that it will be in a position to contact with hinge lock as in **figure 9.1**.

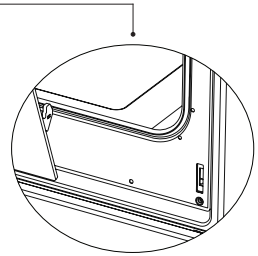

Figure 9.2

For easier removal of oven door, when it comes close to closed position, hold the cover with two hands as in **figure 9.2** and pull upwards.

Reversely perform respectively what you did while opening door to reinstall oven door back.

Cleaning Oven Glass

Lift by pressing on plastic latches on left and right side as shown in figure 10 and pulling the profile toward yourself as in figure 11. Glass is released after profile is removed as shown in figure 12. Remove the released glass by pulling toward yourself carefully. Outer glass is fixed to oven door profile. You can perform glass cleaning easily after glasses are released. You can mount glasses back by performing the operations reversely after cleaning and maintenance are completed. Ensure that profile is seated properly in place.

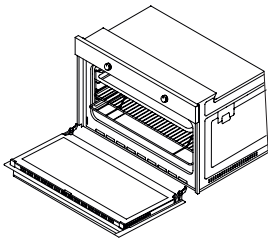

Figure 10

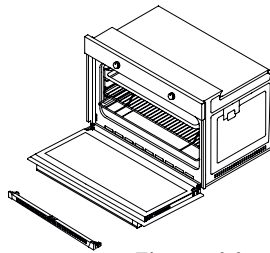

Figure 11

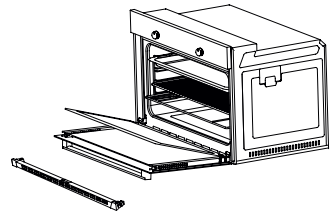

Figure 12

Catalytic Panel *

It is located behind the wire racks of the oven, at the right and left walls of oven cavity. Catalytic panel removes offensive odour and provides using your appliance at its best performance. Over time, oil and food odours permeate into enamelled oven walls and heating elements. Catalytic panel absorbs any food and oil odours, and burns them during cooking to clean your oven.

Detaching catalytic panel

To remove catalytic panel; first remove the wire racks. Once wire racks are removed, catalytic panel will be free. It is advised to replace the catalytic panel once every 2-3 years.

Rack Positions:

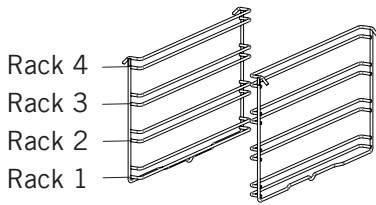

It is important to place the wire grill into the oven properly. Do not allow wire rack to touch rear wall of the oven. Rack positions are shown in the next figure. You may place a deep tray or a standard tray in the lower and upper wire racks.

Installing and removing wire racks

To remove wire racks, press the clips shown with arrows in the figure, first remove the lower, and then the upper side from installation location. To install wire racks; reverse the procedure for removing wire rack.

Replacing Oven Lamp

WARNING: To avoid electric shock, ensure that the appliance circuit is open before changing the lamp. (having circuit open means power is off) First disconnect the power of appliance and ensure that appliance is cold.

Remove the glass protection by turning as indicated in the figure on the left side. If you have difficulty in turning, then using plastic gloves will help you in turning.

Then remove the lamp by turning, install the new lamp with same specifications.

Reinstall glass protection, plug the power cable of appliance into electrical socket and complete replacement. Now you can use your oven.

Type G9 Lamp



220-240 V, AC
15-25 W

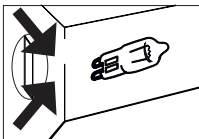
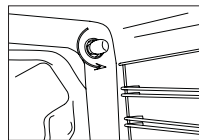

Figure 13

Type E14 Lamp



220-240 V, AC
15 W



Figure 14

TROUBLESHOOTING

You may solve the problems you may encounter with your product by checking the following points before calling the technical service.

Check Points

In case you experience a problem about the oven, first check the table below and try out the suggestions.

Problem	Possible Cause	What to Do
Oven does not operate.	Power supply not available.	Check for power supply.
Oven stops during cooking.	Plug comes out from the wall socket.	Re-install the plug into wall socket.
Turns off during cooking.	Too long continuous operation.	Let the oven cool down after long cooking cycles.
	Cooling fan not operating.	Listen the sound from the cooling fan.
	Oven not installed in a location with good ventilation.	Make sure clearances specified in operating instructions are maintained.
	More than one plugs in a wall socket.	Use only one plug for each wall socket.
Outer surface of the oven gets very hot during operation.	Oven not installed in a location with good ventilation.	Make sure clearances specified in operating instructions are maintained.
Oven door is not opening properly.	Food residues jammed between the door and internal cavity.	Clean the oven well and try to re-open the door.
Internal light is dim or does not operate.	Foreign object covering the lamp during cooking.	Clean internal surface of the oven and check again.
	Lamp might be failed.	Replace with a lamp with same specifications.
Electric shock when touching the oven.	No proper grounding.	Make sure power supply is grounded properly.
	Ungrounded wall socket is used.	

Problem	Possible Cause	What to Do
Water dripping.	Water or steam may generate under certain conditions depending on the food being cooked. This is not a fault of the appliance.	Let the oven cool down and than wipe dry with a cloth.
Steam coming out from a crack on oven door.		
Water remaining inside the oven.		
The cooling fan continues to operate after cooking is finished.	The fan operates for a certain period for ventilation of internal cavity of the oven.	This is not a fault of the appliance; therefore you don't have to worry.
Oven does not heat.	Oven door is open.	Close the door and restart.
	Oven controls not correctly adjusted.	Read the section regarding operation of the oven and reset the oven.
	Fuse tripped or circuit breaker turned off.	Replace the fuse or reset the circuit breaker. If this is repeating frequently, call an electrician.
Smoke coming out during operation.	When operating the oven for the first time	Smoke comes out from the heaters. This is not a fault. After 2-3 cycles, there will be no more smoke.
	Food on heater.	Let the oven to cool down and clean food residues from the ground of the oven and surface of upper heater.
When operating the oven burnt or plastic odour coming out.	Plastic or other not heat resistant accessories are being used inside the oven.	At high temperatures, use suitable glassware accessories.
Oven does not cook well.	Oven door is opened frequently during cooking.	Do not open oven door frequently, if the food you are cooking does not require turning. If you open the door frequently internal temperature drops and therefore cooking result will be influenced.

HANDLING RULES

- 1.** Do not use the door and/or handle to carry or move the appliance.
- 2.** Carry out the movement and transportation in the original packaging.
- 3.** Pay maximum attention to the appliance while loading/unloading and handling.
- 4.** Make sure that the packaging is securely closed during handling and transportation.
- 5.** Protect from external factors (such as humidity, water, etc.) that may damage the packaging.
- 6.** Be careful not to damage the appliance due to bumps, crashes, drops, etc. while handling and transporting and not to break or deform it during operation.

RECOMMENDATIONS FOR ENERGY SAVING

Following details will help you use your product ecologically and economically.

- 1.** Use dark coloured and enamel containers that conduct the heat better in the oven.
- 2.** As you cook your food, if the recipe or the user manual indicates that pre-heating is required, pre-heat the oven.
- 3.** Do not open the oven door frequently while cooking.
- 4.** Try not to cook multiple dishes simultaneously in the oven. You may cook at the same time by placing two cookers on the wire rack.
- 5.** Cook multiple dishes successively. The oven will not lose heat.
- 6.** Turn off the oven a few minutes before the expiration time of cooking. In this case, do not open the oven door.
- 7.** Defrost the frozen food before cooking.

ENVIRONMENTALLY-FRIENDLY DISPOSAL



Dispose of packaging in an environmentally-friendly manner.

This appliance is labelled in accordance with European Directive 2012/19/EU concerning used electrical and electronic appliances (waste electrical and electronic equipment - WEEE). The guideline determines the framework for the return and recycling of used appliances as applicable throughout to the EU.

PACKAGE INFORMATION

Packaging materials of the product are manufactured from recyclable materials in accordance with our National Environment Regulations. Do not dispose of the packaging materials together with the domestic or other wastes. Take them to the packaging material collection points designated by the local authorities.

Warranty Information: AU

AUSTRALIAN WARRANTY TERMS & CONDITIONS COOKING APPLIANCES

This document sets out the terms and conditions of the product warranties for Residentia Group Appliances. It is an important document. Please keep it with your proof of purchase documents in a safe place for future reference should you require service for your Appliance.

1. IN THIS WARRANTY

- (a) 'acceptable quality' as referred to in clause 10 of this warranty has the same meaning referred to in the ACL;
 - (b) 'ACL' means Trade Practices Amendment (Australian Consumer Law) Act (No.2) 2010;
 - (c) 'Appliance' means any Residentia Group product purchased by you accompanied by this document;
 - (d) 'ASR' means Residentia Group authorised service representative;
 - (e) 'Residentia Group' means Residentia Group Pty Ltd of 165 Barkly Avenue Burnley VIC, ACN 600 546 656 in respect of Appliances purchased in Australia;
 - (f) 'major failure' as referred to in clause 10 of this warranty has the same meaning referred to in the ACL and includes a situation when an Appliance cannot be repaired or it is uneconomic for Residentia Group, at its discretion, to repair an Appliance during the Warranty Period;
 - (g) 'Warranty Period' means:
 - (i) where the Appliance is used for personal, domestic or household use (i.e. normal single family use) as set out in the instruction manual, the Appliance is warranted against manufacturing defects for 24 months (or 36 months where a valid extended warranty registration has occurred), following the date of original purchase of the Appliance;
 - (h) 'you' means the purchaser of the Appliance not having purchased the Appliance for re-sale, and 'your' has a corresponding meaning.
- 2. This warranty only applies to Appliances purchased and used in Australia and is in addition to (and does not exclude, restrict, or modify in any way) any non-excludable statutory warranties in Australia.
 - 3. During the Warranty Period Residentia Group or its ASR will, at no extra charge if your Appliance is readily accessible for service, without special equipment and subject to these terms and conditions, repair or replace any parts which it considers to be defective. Residentia Group or its ASR may use remanufactured parts to repair your Appliance. You agree that any replaced Appliances or parts become the property of Residentia Group. This warranty does not apply to light globes, batteries, filters or similar perishable parts.
 - 4. Parts and Appliances not supplied by Residentia Group are not covered by this warranty.
 - 5. You will bear the cost of transportation, travel and delivery of the Appliance to and from Residentia Group or its ASR. If you reside outside of the service area, you will bear the cost of:
 - (a) travel of an authorised representative;
 - (b) transportation and delivery of the Appliance to and from Residentia Group or its ASR, in all instances, unless the Appliance is transported by Residentia Group or its ASR, the Appliance is transported at the owner's cost and risk while in transit to and from Residentia Group or its ASR.
 - 6. Proof of purchase is required before you can make a claim under this warranty.
 - 7. You may not make a claim under this warranty unless the defect claimed is due to faulty or defective parts or workmanship. Residentia Group is not liable in the following situations (which are not exhaustive):

- (a) the Appliance is damaged by:
 - (i) accident
 - (ii) misuse or abuse, including failure to properly maintain or service
 - (iii) normal wear and tear
 - (iv) power surges, electrical storm damage or incorrect power supply
 - (v) incomplete or improper installation
 - (vi) incorrect, improper or inappropriate operation
 - (vii) insect or vermin infestation
 - (viii) failure to comply with any additional instructions supplied with the Appliance;
 - (b) the Appliance is modified without authority from Residentia Group in writing;
 - (c) the Appliance's serial number or warranty seal has been removed or defaced;
 - (d) the Appliance was serviced or repaired by anyone other than Residentia Group, an authorised repairer or ASR.
8. This warranty, the contract to which it relates and the relationship between you and Residentia Group are governed by the law applicable where the Appliance was purchased.
9. To the extent permitted by law, Residentia Group excludes all warranties and liabilities (other than as contained in this document) including liability for any loss or damage whether direct or indirect arising from your purchase, use or non use of the Appliance.
10. For Appliances and services provided by Residentia Group in Australia, the Appliances come with a guarantee by Residentia Group that cannot be excluded under the Australian Consumer Law. You are entitled to a replacement or refund for a major failure and for compensation for any other reasonably foreseeable loss or damage. You are also entitled to have the Appliance repaired or replaced if the Appliance fails to be of acceptable

quality and the failure does not amount to a major failure. The benefits to you given by this warranty are in addition to your other rights and remedies under a law in relation to the Appliances or services to which the warranty relates.

- 11. At all times during the Warranty Period, Residentia Group shall, at its discretion, determine whether repair, replacement or refund will apply if an Appliance has a valid warranty claim applicable to it.
- 12. Missing parts are not covered by warranty. Residentia Group reserves the right to assess each request for missing parts in a case by case basis. Any parts that are not reported missing in the first week after purchase will not provide free of charge.
- 13. To enquire about claiming under this warranty, please follow these steps:
 - (a) carefully check the operating instructions, user manual and the terms of this warranty;
 - (b) have the model and serial number of the Appliance available;
 - (c) have the proof of purchase (e.g. an invoice) available;
 - (d) telephone the numbers shown below.
- 14. You accept that if you make a warranty claim, Residentia Group and its ASR may exchange information in relation to you to enable Residentia Group to meet its obligations under this warranty.

IMPORTANT

Before calling for service, please ensure that the steps in point 13 have been followed.

Telephone contact

- ▶ Service: Please call 1300 11 HELP (4357)

The Australian Consumer Law requires the inclusion of the following statement with this warranty:

Our goods come with guarantees that cannot be excluded under the Australian Consumer Law. You are entitled to a replacement or refund for a major failure and for compensation for any other reasonably foreseeable loss or damage. You are also entitled to have the goods repaired or replaced if the goods fail to be of acceptable quality and the failure does not amount to a major failure.

Warranty Information: NZ

NEW ZEALAND WARRANTY TERMS & CONDITIONS APPLIANCES

To help care for your investment, be sure to register your appliance online. Registration will help you if you need to arrange service in the future, and serves as a record of your purchase – including critical information like model number and serial number – that you can refer to at any time.

Simply visit the below website, or ask your retailer for help:

www.inalto.co.nz/register

WARRANTY:

These products are covered by a warranty for a period of 24 months from the date of purchase, subject to the following conditions*. The warranty covers rectification free of charge of any fault arising from defective materials or components, or faulty workmanship or assembly.

* The conditions above mentioned are:

1. That the purchaser carefully follows all instructions packed with the product;
2. That the purchaser and/or installer carefully follows the installation instructions provided and complies with electrical wiring regulations, gas and/or plumbing codes;
3. That the purchaser carefully follows instructions provided in the owner's handbook relating to the proper use and care of the product and does not use the product for any purpose other than the domestic use for which it has been designed;
4. Commercial use of the product for professional or industrial purposes will void this warranty.;
5. That the product was purchased and installed in New Zealand;
6. That this warranty does not extend to:
 - a) optional glass lids for hobs apart from claims which relate to mechanical or physical damage thereof at the date of purchase;
 - b) 'consumable' parts such as light bulbs or filters;
 - c) damage to ceramic glass caused by liquid or solid spill-overs, lack of maintenance, or impact;
 - d) damage to surface coatings caused by cleaning or maintenance using products not recommended by the owner's handbook;
 - e) defects caused by normal wear and tear, accident, negligence, alteration, misuse or incorrect installations;
 - f) a product dismantled, repaired or serviced by any serviceman other than an authorised service agent;
 - g) a product not in possession of the original purchaser;
 - h) damage caused by power outages or surges
 - i) damage caused by pests (eg. rats, cockroaches etc.)

7. That if the product is a freestanding microwave oven or small appliance it must be returned to the dealer/ retailer for servicing. These products, unless stated otherwise, have a 12 month warranty from original date of purchase with 24 months on the microwave magnetron; Waste disposers have a 12 month warranty.
8. The provision of service under this warranty is limited by a 25km boundary from the retailer where the product was purchased except for microwaves. Such travelling outside of these limits will incur commercial cost to be paid by you, regulated by the number of kilometres travelled beyond the 25km limit (50km return trip). Microwaves are to be delivered to the nearest authorised service agent by the customer.

Please refer to your user manual for any further conditions that may apply to your specific model.

Nothing herein contained shall be construed in any way as excluding or limiting your rights under the Consumer Guarantees Acts 1993.

For Service please visit www.applico.co.nz/service or contact the dealer/retailer from whom you purchased the product from or call the 0800 number listed below. If you are unable to establish the date of purchase, or the fault is not covered by this warranty, or if the product is found to be in working order, you will be required to bear all service call charges.

Registration of this warranty constitutes acceptance of the terms and conditions of this warranty.

Should you require any assistance, please call Customer Services on 0800 763 448.

Distributed by Applico Ltd.
www.applico.co.nz
July 2019

After registering your appliance online, we recommend you fill out the below information for your reference and keep this warranty card in a safe place.

THIS WARRANTY IS VALID IN NEW ZEALAND ONLY.

Attach your receipt
to this page



DESIGNED IN MELBOURNE

INALTO?

FOR ALL AUSTRALIAN HOMES

WWW.INALTO.HOUSE



E2447